

Simulation of Performance Analysis of the IEEE 802.11 DCF

Manal Al-Sarraf¹

¹ Department of Electronic Engineering Technology, College of Technological Studies/Public Authority for Applied Education and Training, Kuwait

Abstract:

The primary medium access control (MAC) technique of 802.11 (Wireless Local Area Networks) is called distributed coordination function (DCF). DCF is a carrier sense multiple access with collision avoidance (CSMA/CA) scheme with binary exponential backoff (BEB), where a node increases its contention window CW upon every packet collision. The performance of an IEEE 802.11 network depends on the operation of this backoff mechanism.

Therefore, the aim of this work is to analyze the performance of IEEE 802.11 DCF, which is done by both analytical and simulation study. In the analytical study, MATHLAB is used to solve the equations numerically to calculate the throughput, where the simulation study is conducted using NS-2 to measure the throughput. The throughput is measured in the assumption of ideal channel conditions and a fixed number of nodes, each always having a packet available for transmission (saturation conditions). The evaluation is done for both cases of basic access and RTS/CTS mechanisms.

Key Word: 802.11; DCF; CSMA/CA; Contention Window; Backoff; Throughput; RTS/CTS.

Date of Submission: 13-02-2022

Date of Acceptance: 28-02-2022

I. Introduction

The IEEE 802.11 is the predominant technology for wireless local area networks (WLAN). One of the most important elements of the 802.11 is its medium-access control (MAC); the MAC protocol is used to provide arbitrated access to a shared medium, in which several terminals access and compete for using the network resources. The IEEE 802.11 wireless networks employ the distributed coordination function (DCF) as the primary access mechanism; it is based on the carrier sense multiple access with collision avoidance (CSMA/CA) protocol and binary exponential backoff [2].

In CSMA/CA, the node first senses the medium (Carrier Sense) and waits a random amount of time before attempting to transmit in order to avoid collisions (Collision Avoidance). The collision avoidance procedure in 802.11 is defined by a Binary Exponential Backoff (BEB) algorithm as follows. The random amount of time that a node waits before attempting to transmit is called a backoff value and is chosen uniformly at random between 0 and a value known as contention window (CW), which is initialized to CW_{min}. If while attempting to transmit, the node experiences a collision, the value of CW is doubled until it reaches a pre-defined maximum value CW_{max}. Following successful transmission, the value of CW is reset to CW_{min} [3].

The performance of an IEEE 802.11 network largely depends on the operation of this backoff mechanism. Accordingly, there have been several research efforts for analyzing the saturation throughput achieved under DCF in single hop WLANs. The binary exponential backoff (BEB) of DCF is used for resolving collisions among terminals attempting to simultaneously transmit on the channel. To ensure packet transmission reliability, MAC acknowledgement frames (ACK) are used to indicate the correct reception of the data packets. When an ACK frame is not received upon a transmission, the sender assumes its packet has been lost due to collision and accordingly invokes the BEB mechanism for retransmission [2].

In this work, a simple wireless network model is designed to compute the performance of DCF for both standardized access mechanisms (Basis and RTS/CTS). The performance has been computed in the assumption of ideal channel conditions (i.e., no hidden terminals) and a fixed number of nodes, each always having a packet available for transmission. In other words, the transmission queue of each node is assumed to be always nonempty (saturation conditions). Which is defined as the limit reached when the offered load increases, and it represents the maximum load that the system can carry in stable condition.

The performance evaluation of 802.11 has been carried out by means of analytical and simulation models with simplified exponential backoff rule assumptions by employing the two-dimensional Markov Chain analysis used in [3].

II. OVERVIEW OF THE IEEE 802.11 DCF

2.1 Medium Access Control

The MAC sublayer is responsible for the channel access procedures. The IEEE 802.11 MAC protocol is specified in terms of *coordination functions* that determine when a node is allowed to transmit and when it may be able to receive data units over the wireless medium [2].

The IEEE 802.11 defines two basic access methods for sharing the single channel of communication between nodes in a WLAN; one is a fully distributed mechanism called distributed coordination function (DCF), which is the main and mandatory protocol of 802.11. The other is a centralized mechanism called point coordinator function (PCF) which is optional and requires centralized access points [1].

The distributed coordination function (DCF) provides support for asynchronous data transfer on a best-effort basis. Under this function, the transmission medium operates in the contention mode exclusively, requiring all nodes to contend for the channel for each packet transmitted. The point coordination function (PCF), which may be implemented by an access point (AP) to support connection-oriented time-bounded transfer. This AP manages the usage of channel among nodes in its area. The time periods during which the channel is controlled by AP are called CFP (Contention Free Period) [1].

2.2 Distributed Coordination Function

The distributed coordination function (DCF) is the basic access method used to support asynchronous data transfer on a best-effort basis. The access control in ad hoc networks uses only the DCF. Infrastructure networks can operate using just DCF or a coexistence of the DCF and PCF. DCF supports contention services. Contention services imply that each node with data queued for transmission must contend for the channel and, once the given data is transmitted, must recontend for the channel for all subsequent frames. Contention services are designed to promote fair access to the channel for all nodes [1].

The DCF is based on the carrier sensing multiple access with collision avoidance (CSMA-CA) protocol. Carrier sensing involves monitoring the channel to determine whether the medium is idle or busy. If the medium is busy, it makes no sense for a node to transmit its frame and cause a collision and waste bandwidth. Instead, the node should wait until the channel becomes idle. When this happens, there is another problem: Other nodes may have also been waiting for the channel to become idle. If the protocol is to transmit immediately after the channel becomes idle, then collisions are likely to occur; and because collision detection is not possible, the channel will be wasted for an entire frame duration. A solution to this problem is to randomize the times at which the contending nodes attempt to seize the channel [2].

DCF describes two techniques to employ for packet transmission. The default scheme is a two-way handshaking technique called basic access mechanism. This mechanism is characterized by the immediate transmission of a positive acknowledgement (ACK) by the destination node, upon successful reception of a packet transmitted by the sender node. Explicit transmission of an ACK is required since, in the wireless medium, a transmitter cannot determine if a packet is successfully received by listening to its own transmission [2].

Figure 1 shows the basic CSMA-CA operation [1]. All nodes are obliged to remain quiet for a certain minimum period after a transmission has been completed, called the interframe space (IFS). The length of the IFS depends on the type of frame that the node is about to transmit. High-priority frames must only wait the short IFS (SIFS) period before they contend for the channel. Frame types that use SIFS are ACK frames and CTS frames. The PCF interframe space (PIFS) is intermediate duration and is used by the PCF to gain priority access to the medium at the start of a contention free period. The DCF interframe space (DIFS) is used by the DCF to transmit data [1].

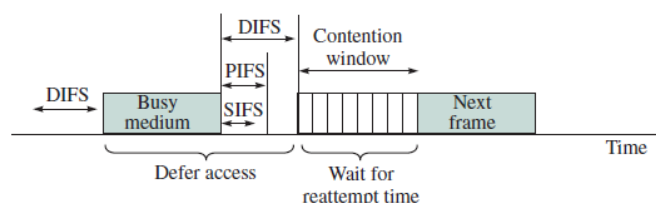

Figure 1: Basic CSMA/CA operation

In addition to the basic access, an optional four-way handshaking technique, known as request-to-send/clear-to-send (RTS/CTS) mechanism has been standardized. Before transmitting a packet, a node operating in RTS/CTS mode “reserves” the channel by sending a special Request-To-Send short frame. The destination

node acknowledges the receipt of an RTS frame by sending back a Clear-To-Send frame, after which normal packet transmission and ACK response occurs. Since collision may occur only on the RTS frame, and it is detected by the lack of CTS response, the RTS/CTS mechanism allows to increase the system performance by reducing the duration of a collision when long messages are transmitted. As an important side effect, the RTS/CTS scheme designed in the 802.11 protocol is suited to combat the so-called problem of Hidden Terminals, which occurs when pairs of mobile nodes result to be unable to hear each other [2].

Figure 2 illustrates the transmission of frames using the RTS/CTS mechanism [1]. A node with a packet to transmit first senses the medium. If the medium is idle for at least a certain period DCF interframe space DIFS, it will immediately request the channel by sending a short control frame request to send (RTS) to the receiver node. If the receiver correctly receives the RTS, it will reply with a short control frame clear to send (CTS). Once the sender receives the CTS, it will start to transfer DATA. After the successful reception of DATA, the receiver sends an ACK to the sender. The exchange of RTS/CTS prior to the actual data transmission reduces the high collision probability by distributing the medium reservation information and solves the hidden terminal problem. The RTS/CTS contains a duration field indicating the time (in microseconds) after the end of present frame transmission that the channel will be reserved to complete the data or management frame transmission. Any node within the transmission range of either the sending node or the receiving node hears the RTS/CTS exchange will learn about the medium reservation and adjust its network allocation vector (NAV), which indicates the amount of time that the node should defer [1].

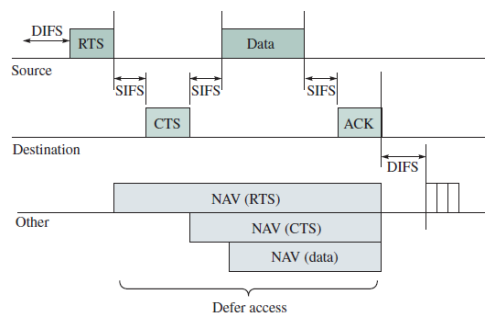

Figure 2: Transmission of frames with RTS/CTS

The collision will mostly happen when the current node completes its transmission and multiple nodes are waiting to contend for the channel. Thus, each node with data to transmit will generate a random backoff number from the range $[0, CW]$ for an additional deferring time after the channel is idle for a DIFS time, where CW is the contention window size maintained by each node. The backoff counter is decremented as long as the channel is sensed idle, stopped when a transmission is detected on the channel, and restarted when the channel is sensed idle again for more than DIFS [1].

Once the backoff counter reaches zero, the sending node will reserve the channel by exchanging RTS/CTS as described above. If a node sends RTS but does not receive CTS within certain time, the node will defer by doubling its CW size and choosing a random value from the new range and retransmit RTS with limited times. Alternatively, if the ACK is not received within certain time, the sending node will retransmit the DATA packet [1].

For IEEE 802.11 time is slotted in time periods that corresponds to a Slot_Time. The Slot_Time used in IEEE 802.11 is much smaller than a frame and is used to define the IFS intervals and to determine the backoff timer for nodes in the contention period. The slot time size σ is set equal to the time needed at any node to detect the transmission of a packet from any other node. As shown in Figure 3, it depends on the physical layer, and it accounts for the propagation delay, for the time needed to switch from the receiving to the transmitting state ($RX_TX_Turnaround_Time$), and for the time to signal to the MAC layer the state of the channel (busy detect time) [3].

PHY	Slot Time (σ)
FHSS	50 μs
DSSS	20 μs
IR	8 μs

Figure 3: Slot Time Values for the three PHY 802.11 Standards

III. THROUGHPUT EVALUATION

Bianchi [3] presents a Markov Chain model to compute the 802.11 DCF throughput. The idea of Bianchi's model is to analyze IEEE 802.11 DCF and find a closed-form formula to compute the saturation throughput and the probability of a packet transmission failure under the assumption of finite number of terminals and ideal channel conditions (no hidden terminals). Bianchi uses a two-dimensional Markov Chain [3] of $m+1$ backoff stages; each stage represents the backoff time counter of a node (Figure 4). A transition through the chain takes place upon collision and successful transmission to higher stage (due to collision) and lowest stage (due to successful transmission).

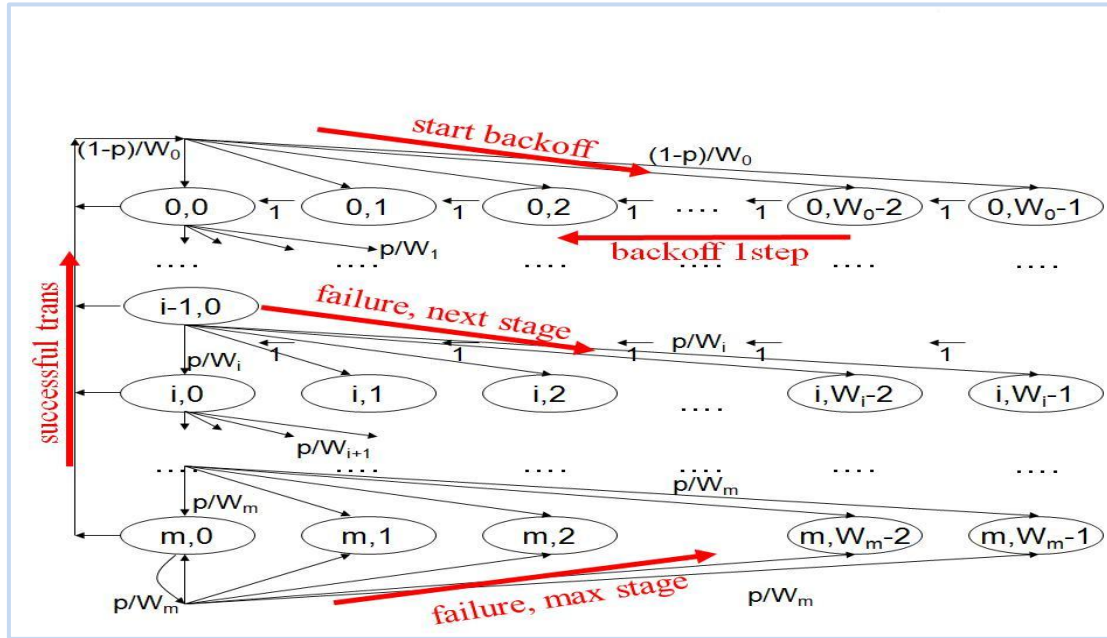

Figure 4: Markov Chain Model

The model assumes a time scale where t and $t+1$ correspond to the beginning of two consecutive slot times. Each station sets its contention window at the beginning of transmission and decrement its backoff counter at the beginning of each time slot. From the analysis of the model, Bianchi found two nonlinear equations that has a unique solution and can be solved numerically to calculate stationary probability (τ) and probability of collision (p)[3]:

$$\tau = \frac{2(1 - 2p)}{(1 - 2p)(W + 1) + pW(1 - (2p)^m)} \tag{1}$$

$$p = 1 - (1 - \tau)^{n-1} \tag{2}$$

Once these probabilities are found, the saturation throughput (average payload transmitted in a slot time) can be calculated as follows:

$$S = \frac{P_s P_{tr} E[P]}{(1 - P_{tr})\sigma + P_{tr} P_s T_s + P_{tr} (1 - P_s) T_c} \tag{3}$$

Where,

- $P_{tr} = 1 - (1 - \tau)^n$, is the probability that there is at least one transmission in the considered slot time.
- $E[P]$ is the average packet payload size.
- $P_s = \frac{n\tau(1-\tau)^{n-1}}{P_{tr}}$ is the probability of successful transmission.
- σ is the duration of idle period (single slot time).
- T_s is the average time needed to transmit a packet of size L .
 - $T_s = PHY_{hdr} + MAC_{hdr} + E[P] + SIFS + ACK + DIFS + 2\delta$ for Basic Access

- $T_s = RTS + CTS + 3 SIFS + PHY_{hdr} + MAC_{hdr} + E[P] + ACK + DIFS + 4\delta$ for RTS/CTS
- T_c is the average time spent in the collision.
 - $T_c = PHY_{hdr} + MAC_{hdr} + E[P] + DIFS + \delta$ for Basic Access
 - $T_c = RTS + DIFS + \delta$ for RTS/CTS

Therefore, the aim of this work is to simulate the performance of IEEE 802.11 and solve the nonlinear system proposed by Bianchi (equations 1, and 2).

IV. MODEL VALIDATION (RESULTS)

The performance evaluation of 802.11 has been carried out by means of simulation and analytical models with simplified exponential backoff rule assumptions by employing a two-dimensional Markov Chain analysis. To validate the model, the simulation has been done using NS-2, and solving the equations has been done using MATLAB program.

In this work an extremely simple wireless network model was designed to compute the performance of DCF for both standardized access mechanisms. That performance has been computed with the assumption of constant and independent collision probability of a packet transmitted by each station. Also, saturation (asymptotic) throughput performance was assumed, which is defined as the limit reached by the system throughput as the offered load increases, and it represents the maximum load that the system can carry in stable condition. The simulated offered load has been generated according to an arrival process of fixed size packets (payload equal to 8184 bits).

4.1 Analytical Part (MATLAB):

The numerical evaluation of the 802.11 throughput performance was done by solving the non-linear system of equations (1) & (2). These equations have the two unknowns τ and p , where τ is the probability that a station transmits in a randomly chosen slot time, whereas p is the probability of a collision seen by a packet being transmitted on the channel.

The non-linear system of equations was solved by assuming an initial value for p and find the corresponding value of τ . After that P_{tr} was computed which is the probability that there is at least one transmission in the considered slot time, and it was computed by the following equation: $P_{tr} = 1 - (1 - \tau)^n$. Then, P_s was calculated which is the probability that a transmission occurring on the channel is successful by using this equation: $P_s = \frac{n\tau(1-\tau)^{n-1}}{P_{tr}}$.

After that, the average time the channel is sensed busy because of successful transmission (T_s) and the average time the channel is sensed busy by each station during a collision (T_c) was found using these equations for the Basic Access mechanism:

$$T_s = PHY_{hdr} + MAC_{hdr} + E[P] + SIFS + ACK + DIFS + 2\delta$$

$$T_c = PHY_{hdr} + MAC_{hdr} + E[P] + DIFS + \delta$$

The same average time for the RTS/CTS mechanism was computed using these equations:

$$T_s = RTS + CTS + 3 SIFS + PHY_{hdr} + MAC_{hdr} + E[P] + ACK + DIFS + 4\delta$$

$$T_c = RTS + DIFS + \delta$$

Then the throughput (S) was calculated by substituting the previous computed values in equation (3), for different number of stations and different window sizes (W). The backoff stages m was assumes to be 3 for both access methods: Basic and RTS/CTS.

4.1.1 System Model:

In this section, I will show the obtained results of the analytical study. The numerical evaluation of the 802.11 throughput performance was done by using MATLAB. The throughput was computed for different number of stations starting with ($n=4$) until ($n=36$) using the values shown in Table 1.

Table 1: System Parameters Used to Obtain the Numerical Results

System Parameter	
Packet payload	8184 bits = 1023 bytes
MAC header	272 bits
PHY header	128 bits
ACK	112 bits + PHY header
RTS	160 bits + PHY header
CTS	112 bits + PHY header
Channel Bit Rate	1 M bit/sec

Propagation delay	1 μsec
Slot Time	50 μsec
SIFS	28 μsec
DIFS	128 μsec
Number of backoff stages	3

4.1.2 Results

The analytical results shown below in Table 2 were obtained for the value of a contention window size $W=31$ and $W=128$.

Table 2: Throughput Vs. number of nodes

#Nodes	Basic		RTS/CTS	
	W = 31	W = 128	W = 31	W = 128
4	8.23E+05	8.17E+05	8.32E+05	7.86E+05
9	7.80E+05	8.28E+05	8.36E+05	8.19E+05
16	7.65E+05	8.12E+05	8.36E+05	8.30E+05
25	7.58E+05	7.92E+05	8.36E+05	8.33E+05
36	7.45E+05	7.77E+05	8.36E+05	8.35E+05

The results for the throughput (S) vs. number of stations (n) were plotted as shown in Figure 5 below.

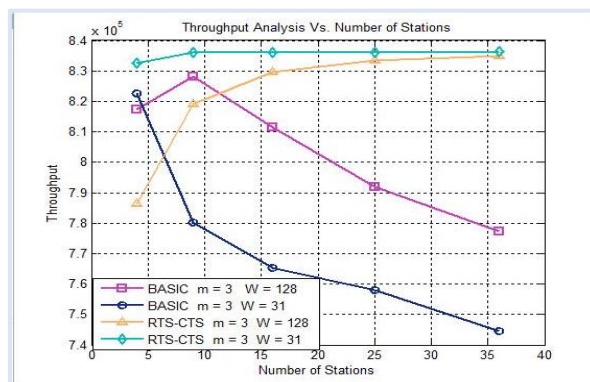

Figure 5: Throughput Analysis

4.1.3 Discussion

Obviously, we can see that the throughput under RTS/CTS method is higher than under Basic method. In the Basic Access method, as the window size and the number of stations increased, the throughput values increased to a certain point then start to decrease due to the increase of the delay time to avoid collision. Therefore, the throughput for the basic access scheme strongly depends on the number of stations in the network. Whereas in the RTS/CTS, the throughput keeps increasing as the number of stations and window size increased because RTS/CTS method solves the collision problem as it avoids the collision between the long data packets and the collision occurs during RTS and CTS period which is shorter than the data packets.

4.2 Simulation Part (NS-2):

In this section Bianchi’s model was simulated for both cases of Basic Access and RTS/CTS mechanisms using NS-2. The simulation runs several times to see the effect of changing these parameters on the throughput:

- I. Contention Window Size
- II. Radio Propagation Model
- III. Channel Bit Rate

4.2.1 System Model

- Environment: single hop network where all nodes are in range of each other. All nodes are involved in 2-constant bit rate (CBR) conversations (one as a source and one as a destination).
- Agent: UDP connection and the CBR (Constant Bit Rate) application over it with packet transmission interval (the time interval between transmission of packets) = 0.01, because each station always has a packet available for transmission.
- Radio propagation model: Two-ray ground and Free space.
- Packet size = 1023 bytes

- Bandwidth: 1.0e6 bits/sec
- Contention Window: $CW_{min} = 31, CW_{max} = 1023$ (unless specified)
- Simulation time = 100 sec
- Number of received packets is obtained by the 'grep' command, then the throughput is calculated:

$$Throughput = \#of\ received\ packets * packet\ size * \frac{8}{Simulation\ time} \quad (bits/sec)$$

4.2.2 Results

I. Contention Window Size

Simulate the impact of contention window size on the performance of IEEE 802.11 MAC protocol and study the effect of RTS-CTS. Then obtain throughput vs. number of nodes for different window sizes with a fixed packet size. The results are shown in Table 3 & Table 4.

Table 3: Throughput vs. number of nodes - $CW_{min} = 31, CW_{max} = 1023$

#Nodes	BASIC			RTS/CTS		
	Send	Receive	Throughput	Send	Receive	Throughput
4	39946	10089	825683.76	39937	10133	829284.72
9	89859	9369	766758.96	89876	10009	819136.56
16	159703	9404	769623.36	159773	9626	787791.84
25	249481	9403	769541.52	249450	9425	771342.00
36	359235	9094	744252.96	359302	9134	747526.56

Table 4: Throughput vs. number of nodes - $CW_{min} = 15, CW_{max} = 512$

#Nodes	BASIC			RTS/CTS		
	Send	Receive	Throughput	Send	Receive	Throughput
4	39946	10089	825683.76	39937	10133	829284.72
9	89916	9326	763239.84	89926	10090	825765.60
16	159736	9085	743516.40	159714	9824	803996.16
25	249436	9274	758984.16	249482	9609	786400.56
36	359257	9123	746626.32	359295	9372	767004.48

The results for the throughput (S) and number of stations (n) were plotted as shown in Figure 6 below.

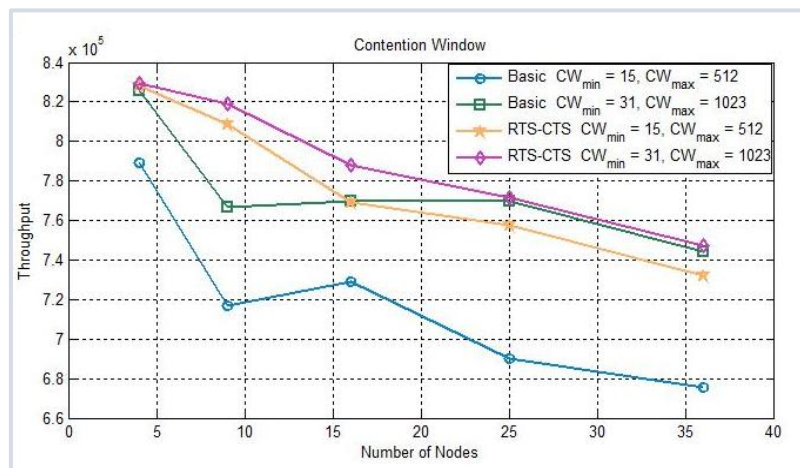

Figure 6: Throughput Vs. number of nodes – Contention Window

II. Radio Propagation Model

Study the effects of the models that are used to predict the received signal power of each packet. At the physical layer of each wireless node, there is a receiving threshold. When a packet is received, if its signal power is below the receiving threshold, it is marked as error and dropped by the MAC layer.

a. Throughput vs. Number of Nodes

Obtain throughput vs. number of nodes for different propagation models: Two Ray Ground, and Free Space. The results are shown in Table 5 & Table 6.

Table 5: Throughput vs. number of nodes – Two Ray Ground

#Nodes	BASIC			RTS/CTS		
	Send	Receive	Throughput	Send	Receive	Throughput
4	39921	9647	789510.48	39990	10121	828302.64
9	89890	8761	717000.24	89881	9882	808742.88
16	159709	8910	729194.40	159771	9399	769214.16
25	249433	8434	690238.56	249498	9260	757838.40
36	359329	8255	675589.20	359307	8947	732222.48

Table 6: Throughput vs. number of nodes – Free Space

#Nodes	BASIC			RTS/CTS		
	Send	Receive	Throughput	Send	Receive	Throughput
4	39946	10089	825683.76	39937	10133	829284.72
9	89859	9369	766758.96	89876	10009	819136.56
16	159703	9404	769623.36	1159773	9626	787791.84
25	249481	9403	769541.52	249450	9425	771342.00
36	359235	9094	744252.96	359302	9134	747526.56

The results for the throughput (S) and number of stations (n) were plotted as shown in Figure 7 below.

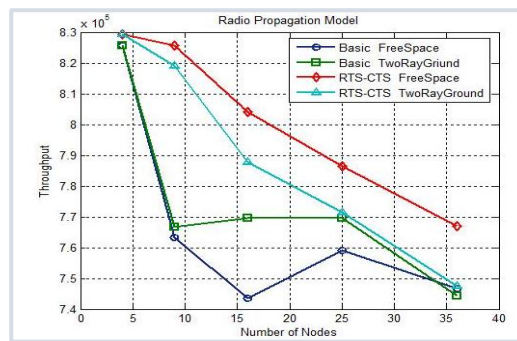

Figure 7: Throughput Vs. number of nodes – Radio Propagation Model

b. Throughput vs. Distance

Obtain throughput vs. distance between 2-nodes for different propagation models (Two Ray Ground, Free Space, and Shadowing with deviation value = 4 dB and packet loss exponent = 3.5). The results are shown in Table 7 & Table 8.

Table 7: Throughput vs. Distance – Basic

Distance(m)	Basic								
	Two Ray Ground			Free Space			Shadowing		
	Send	Receive	Throughput	Send	Receive	Throughput	Send	Receive	Throughput
10	124820	10737	878716.08	124820	10737	878716.08	124820	10737	878716.08
50	124792	10739	878879.76	124792	10739	878879.76	124792	10739	878879.76
90	124833	10736	878634.24	124833	10736	878634.24	124798	10669	873150.96
130	124791	10737	878716.08	124791	10737	878716.08	124818	8815	721419.60
170	124746	10733	878388.72	124746	10733	878388.72	124837	3799	310910.16
210	124836	10735	878552.40	124836	10735	878552.40	124845	1368	111957.12
250	124809	10737	878716.08	124809	10737	878716.08	124856	671	54914.64
290	124783	10739	878879.76	124783	10739	878879.76	124847	275	22506.00
330	124821	10734	878470.56	124821	10734	878470.56	124841	92	7529.28
370	124773	10734	878470.56	124773	10734	878470.56	124887	29	2373.36
410	124824	10736	878634.24	124824	10736	878634.24	124870	2	163.68

Table 8: Throughput vs. Distance – RTS/CTS

Distance (m)	RTS/CTS								
	Two Ray Ground			Free Space			Shadowing		
	Send	Receive	Throughput	Send	Receive	Throughput	Send	Receive	Throughput
10	124842	10012	819382.08	124842	10012	819382.08	124842	10012	819382.08
50	124852	10012	819382.08	124852	10012	819382.08	124852	10012	819382.08

90	124836	10011	819300.24	124836	10011	819300.24	124860	9893	809643.12
130	124864	10010	819218.40	124864	10010	819218.40	124788	7000	572880.00
170	124841	10010	819218.40	124841	10010	819218.40	124828	1580	129307.20
210	124869	10010	819218.40	124869	10010	819218.40	124863	291	23815.44
250	124881	10007	818972.88	124881	10007	818972.88	124897	23	1882.32
290	124872	10008	819054.72	124872	10008	819054.72	124891	0	0
330	124871	10007	818972.88	124871	10007	818972.88	124812	0	0
370	124865	10007	818972.88	124871	10007	818972.88	124825	0	0
410	124857	10007	818972.88	124857	10007	818972.88	124845	0	0

The results for the throughput (S) vs. Distance were plotted for both Basic and RTC-CTS as shown in Figure 8 and Figure 9.

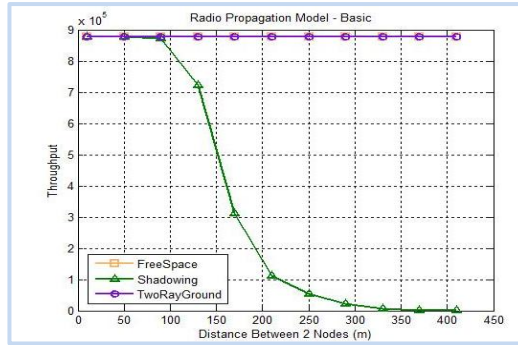

Figure 8: Throughput vs. Distance – Basic

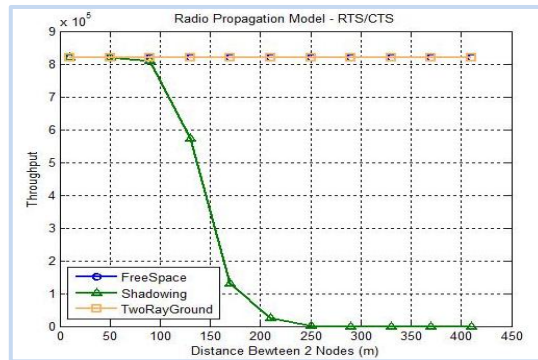

Figure 9: Throughput vs. Distance – RTS/CTS

III. Channel Bit Rate

Study the effect of Channel Bit rate on the performance of IEEE 802.11 MAC protocol, since 802.11 support 4-different values. Obtain throughput vs. number of nodes for different CBR. The results are shown in Table 9 & Table 10.

Table 9: Throughput vs. number of nodes – Basic and Different CBRs

# Nodes	1.0e6			2.0e6			5.5e6			11.0e6		
	Send	Receive	Throughput	Send	Receive	Throughput	Send	Receive	Throughput	Send	Receive	Throughput
4	39946	10089	825683.76	39946	10089	825683.76	39946	10089	825683.76	39946	10089	825683.76
9	89859	9369	766758.96	89859	9369	766758.96	89859	9369	766758.96	89859	9369	766758.96
16	159703	9404	769623.36	159703	9404	769623.36	159703	9404	769623.36	159703	9404	769623.36
25	249481	9403	769541.52	249481	9403	769541.52	249481	9403	769541.52	249481	9403	769541.52
36	359235	9094	744252.96	359235	9094	744252.96	359235	9094	744252.96	359235	9094	744252.96

Table 10: Throughput vs. number of nodes – RTS/CTS and different CBRs

# Nodes	1.0e6			2.0e6			5.5e6			11.0e6		
	Send	Receive	Throughput	Send	Receive	Throughput	Send	Receive	Throughput	Send	Receive	Throughput
4	39937	10133	829284.72	39937	10133	829284.72	39937	10133	829284.72	39937	10133	829284.72
9	89876	10009	819136.56	89876	10009	819136.56	89876	10009	819136.56	89876	10009	819136.56
16	159773	9626	787791.84	159773	9626	787791.84	159773	9626	787791.84	159773	9626	787791.84
25	24950	9425	771342.00	24950	9425	771342.00	24950	9425	771342.00	24950	9425	771342.00
36	359302	9134	747526.56	359302	9134	747526.56	359302	9134	747526.56	359302	9134	747526.56

The results for the throughput (S) vs. number of stations (n) were plotted for both Basic and RTC-CTS as shown in Figure 10 and Figure 11.

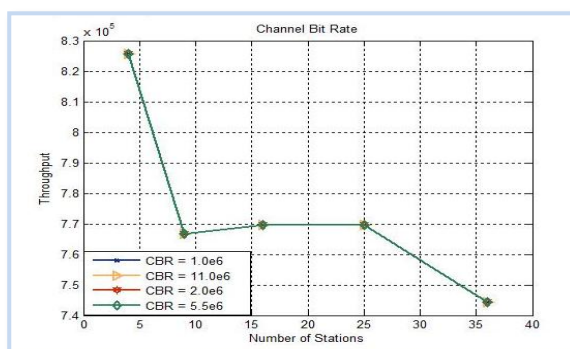

Figure 10: Throughput Vs. number of nodes – Channel Bit Rate (Basic)

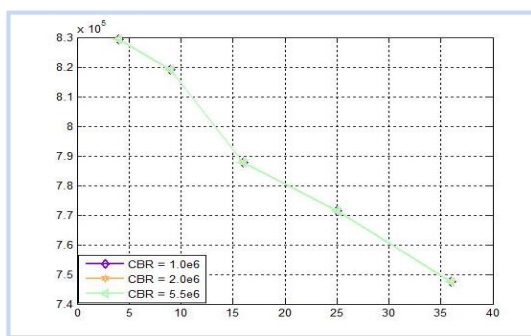

Figure 11: Throughput Vs. number of nodes – Channel Bit Rate (RTS/CTS)

4.2.3 Discussion

I. Contention Window Size

- Access method: Throughput with RTS/CTS method is higher than with Basic method. Because RTS/CTS method solves the collision problem as it avoids the collision between the long data packets.
- Number of nodes: Throughput is decreased as the number of nodes increased.
- Contention window size: Throughput is reduced as the window size reduced. Because when the window size is small, the probability that the stations will select the same backoff number is high.

II. Radio Propagation Model

a. Throughput vs. Number of Nodes

- Number of Nodes: Throughput is decreasing as the number of nodes increased.
- Basic: Two Ray Ground gives better performance than Free Space.
- RTS/CTS: Free Space gives better performance than Two Ray Ground
- Overall RTS/CTS has better performance than Basic.

b. Throughput vs. Distance

Basic:

- Two Ray Ground and Free Space give better performance than Shadowing, and distance has no effect on the throughput.
- Shadowing: throughput remains constant for certain distances values (<100m), then start to decrease as the distance increase.

RTS/CTS:

- Two Ray Ground and Free Space give better performance than Shadowing, and distance has no effect on the throughput.
- Shadowing: throughput remains constant for certain distances values (<100m), then start to decrease as the distance increase.
- Overall: throughput under RTS/CTS is lower than Basic as the distance increasing.

III. Channel Bit Rate

- CBR has no effects on the throughput for both Basic and RTS/CTS.

V. Conclusion

Using the proposed model, the 802.11 throughput performance has been evaluated. The performance of the Basic Access methods strongly depends on the system parameters, mainly minimum contention window, number of stations and the packet size. Conversely, performance is only marginally dependent on the system parameters when the RTS/CTS mechanism is considered. The RTS/CTS mechanism shows a better throughput performance compared with the Basic Access mechanism especially in large network scenarios.

References

- [1]. Alberto Leon-Garcia & Indra Widjaja, Communication Networks: Fundamental Concepts and Key Architectures, Second Edition.
- [2]. James F. Kurose & Keith W. Ross, Computer Networking, A Top-Down Approach, Fifth Edition.
- [3]. Giuseppe Bianchi, "Performance analysis of the IEEE 802.11 distributed coordination function", IEEE Journal on Selected Areas in Communications VOL. 18, NO. 3, MARCH 2000.

Manal Al-Sarraf. "Simulation of Performance Analysis of the IEEE 802.11 DCF." *IOSR Journal of Electrical and Electronics Engineering (IOSR-JEEE)*, 17(1), (2022): pp. 24-34.