

ABC and NFC based unified power quality conditioner for compensating power quality problem

Mr. M. Vishnu Vardhan¹, Dr. P. Sangameswararaju²
^{1,2}(EEE,SV University, Tirupati, India)

Abstract : *In this paper, an artificial bee's colony (ABC) algorithm based neuro fuzzy controller (NFC) will be proposed for improving the performance of UPQC. Here, the error and change of error voltage of the system is to be applied to the neural network. The output of the neural network optimized by ABC algorithm and the network output is enhanced. By the optimized output, the optimal fuzzy rules are generated and the discharging capacitor voltage is calculated from the bias voltage generator. The proposed technique is implemented in MATLAB working platform and the performance is evaluated with voltage sag power quality problem. The power quality compensating performance of the proposed method is compared (ABC-NFC) with ANFIS, ANN, FLC and NFC. Then, the RMS voltage of proposed method is evaluated after solving PQ problem.*

Keywords: *UPQC, Neural Network, Fuzzy Logic controller and Power Quality Issue, Voltage Sag, ABC algorithm.*

I. INTRODUCTION

Electric PQ has become the concern of utilities, end users, manufacturers and all other customers due to the deregulation policy [6]. Any deviations in voltage, current or frequency of power system that results in the failure or disoperation of customer device is referred as PQ problem [2][3][4][8]. PQ problem mainly appears due to the accommodation of power electronic loads such as rectifier, adjustable speed drives, programmable logic controllers, computers, printers, faxes, fluorescent lighting and most other office equipment etc. which will cause the deterioration of voltage and current waveforms [5]. Main PQ problems are voltage sags, micro-interruptions, long interruptions, voltage spikes, voltage swells, voltage fluctuations, harmonic distortion etc. Voltage sag is the most severe PQ problem that shares 70% of all PQ problems [7]. Modern electronic equipments and devices, such as microprocessors, microcontrollers, telecommunications equipment and sensitive computerized equipments etc. are susceptible to PQ problems. So, we need to avoid PQ problem as much as possible. In literature, to avoid PQ problem, there are a variety of Custom Power Devices (CPDs) such as Distribution Static compensator (DSTATCOM), the Dynamic voltage restorer (DVR), uninterruptible power supply (UPS), Solid State Transfer Switch (SSTS), UPQC etc. are discussed [18].

UPQC is an effective CPD for the enhancement of power quality due to its quick response, high reliability and nominal cost [16][17]. It can be used to mitigate the current and voltage-related PQ problems simultaneously in power distribution systems [11]. UPQC employs two inverters that are connected to a common DC link with an energy storage capacitor. The main components of UPQC are shunt and series inverters, DC capacitors, low pass & high pass filters and series transformer [12]. Series inverter is used to compensate voltage related disturbance by injecting opposite voltage in the line where shunt inverter is used to compensate current related disturbance by providing opposite current that cancel the disturbance [9][10][13]. Low and high pass filter help in the reduction of harmonics in the system voltages and currents [14]. DC capacitor supports the both inverters for effective and quick operation during disturbances. But, it has the disadvantage of high discharging time due to which it needs the aid of a proper controller for regulating its voltage.

A NF controller is a control system based on the neural networks (NN) and fuzzy inference systems (FIS). NN is the artificial model of human brain and doesn't need any mathematical model for its structural network. FIS is empirical rules based model is operated based on fuzzy rules and NN is operated based on training dataset. The neural network training dataset are generated from the fuzzy rules. NN is applicable in real life applications like regression analysis, classification, data processing, robotics etc. Fuzzy logic is applicable in real applications like industrial control, human decision making, image processing etc. ABC optimization algorithm is a relatively new member of swarm intelligence. ABC tries to model natural behavior of real honey bees in food foraging [19]. Originally the ABC algorithm was developed for continuous function optimization problems, but it can also be successfully applied to various other optimization problems [20]. It is applicable in real world applications like power systems, management, image classification etc.

In this paper, considered problem is the high discharging time of DC link capacitor. To alleviate such burden in the UPQC due to the capacitor, we proposed an enhanced NF controller based on ABC algorithm for

DC link voltage regulation and detailed in Section 4. Before that, recent related research works are given in Section 2. Section 3 discusses problem formulation of the proposed technique. Section 4 discusses and analyzes the results of the proposed controller and in Section 5 the paper is concluded.

II. RELATED RECENT RESEARCHES: A BRIEF REVIEW

Numerous research works already exist in the literature that compensate power quality problem in power operating system. Some of them are reviewed here. Sobha Rani Injeti et al. [21] have presented a new compensation strategy implemented using an UPQC type compensator. Their proposed compensation scheme enhances the system power quality, exploiting fully DC-bus energy storage and active power sharing between UPQC converters, features not present in DVR and D-STATCOM compensators. The internal control strategy is based on the management of active and reactive power in the series and shunt converters of the UPQC and the exchange of power between converters through UPQC DC-Link. They have proved that their proposed algorithm was efficient and stability accurate, and robust in comparing with the commonly used backward/forward sweep method for weakly meshed networks.

Yash Pal et al. [22] have proposed a control strategy for a three-phase four-wire UPQC for an enhancement of different PQ problems. The UPQC is accomplished by the integration of series and shunt active power filters (APFs) and both APFs share a common DC bus capacitor. The shunt APF is realized by means of a three-phase, four leg voltage source inverter (VSI) and the series APF is realized by means of a three-phase, three legs VSI. A unit vector template technique (UTT) based control method has been used to obtain the reference signals for series APF, whereas the ICos Φ theory has been used for the control of Shunt APF. The performance of the implemented control algorithm has been evaluated in terms of power-factor correction, load balancing, source neutral current mitigation, voltage and current harmonics mitigation, mitigation of voltage sag and swell, and voltage dips in a three-phase four-wire distribution system under a diverse combination of linear and non-linear loads. In the control system, the current/voltage control has been applied on the fundamental supply currents/voltages rather than fast changing APFs currents/voltages, and thus the computational delay and the required sensors have been reduced. The simulation results have been obtained using the MATLAB/Simulink and it proves that the proposed control system could maintain the functionality of the UPQC.

M Siahni et al. [23] have proposed a design of combined operation of UPQC and PV array. Their proposed system is composed of series and shunt inverters, PV array and DC/DC converter which have capable for compensating the voltage sag, swell, interruption, harmonics and reactive power in both islanding and interconnected modes. The benefits of their proposed system are 1) it reduces the expense of PV interface inverter connected to grid by applying UPQC shunt inverter and 2) it has the ability of compensating the voltage interruption using UPQC because of connecting PV to DC link. In the proposed system, P&O technique has been used to reach the maximum power point of PV array. PSCAD/EMTDC software has been used for analyzing operation of the proposed system and the simulation results have proved that their proposed system operates correctly.

K S Ravi Kumar et al. [24] have proposed FL controller and ANN controller for UPQC to enhance the power quality of power distribution network. The proposed FLC and ANN were capable of providing good static and dynamic performances compared to PID controller. UPQC performance mainly depends upon how accurately and quickly reference signals were derived. By using conventional Akagi's principle reference signals was derived. Using conventional compensator data, a FLC was tuned with large number of data points. Then conventional compensator was replaced with fuzzy logic controller and simulated using Matlab/Simulink for R-L load using uncontrolled rectifier. They showed that the UPQC performed better with FLC proposed scheme and eliminates both voltage as well as current harmonics effectively. The ANN controller also performs in a similarly with slightly better voltage compensation It was also observed that the response time for derivation of compensation signals reduced significantly with improved accuracy. They also showed that it had considerable response time for yielding effective compensation in the network.

K. Manimala et al. [26] have described the automatic classification of power quality events using Wavelet Packet Transform (WPT) and Support Vector Machines (SVM). The features of the disturbance signals were extracted using WPT and given to the SVM for effective classification. The two optimization techniques were used to their proposed classification system, such as, genetic algorithm and simulated annealing. Their proposed system was detected the best discriminative features and estimated the best SVM kernel parameters in a fully automatic way. The effectiveness of their proposed detection method was compared with the conventional parameter optimization methods like grid search method, neural classifiers like Probabilistic

Neural Network (PNN), fuzzy k-nearest neighbor classifier (FkNN). They have proved that their proposed method was reliable and produces consistently better results.

Yuksel Oguz et al. [27] have presented a design of adaptive neuro-fuzzy inference system (ANFIS) for the turbine speed control for purpose of improving the power quality of the power production system of a split shaft microturbine. To improve the operation performance of the microturbine power generation system (MTPGS) and to obtain the electrical output magnitudes in desired quality and value (terminal voltage, operation frequency, power drawn by consumer and production power), a controller depended on adaptive neuro-fuzzy inference system was designed. The MTPGS contains the microturbine speed controller, a split shaft microturbine, cylindrical pole synchronous generator, excitation circuit and voltage regulator. Modeling of dynamic behavior of synchronous generator driver with a turbine and split shaft turbine was realized by using the Matlab/Simulink and SimPowerSystems in it. It was observed from the simulation results that with the microturbine speed control made with ANFIS, when the MTPGS was operated under various loading situations, the terminal voltage and frequency values of the system can be settled in desired operation values in a very short time without significant oscillation and electrical production power in desired quality can be obtained.

G Siva Kumar et al. [25] have proposed PSO based ANFIS controller for UPQC to mitigate voltage sag with phase jumps with minimum real power injection in three-phase four-wire distribution systems. To obtain the minimum real power injection by UPQC, an objective function was derived along with practical constraints, such as the injected voltage limit on the series active filter, phase jump mitigation, and angle of voltage injection. PSO had been used to find the solution of the objective function derived for minimizing real power injection of UPQC along with the constraints. ANFIS had been used to make the proposed methodology online for minimum real power injection with UPQC by using the PSO-based data for different voltage sag conditions. They have simulated the proposed method and showed that the real power injection was less compared to the UPQC-Q (with minimum real power injection operation) for different conditions of voltage sags with phase jumps. Thus, the proposed method was more economical because the amount of storage was reduced and demonstrated the effectiveness of the method.

A Mokhtarpour et al. [28] have proposed a configuration structure for single phase UPQC-DG in smart grids for power quality compensation and supplying of load power partly. In the proposed configuration, a DG system with low voltage output had been connected to the DC side of UPQC. It had been composed of one full-bridge inverter, one three winding high frequency transformer and two cycloconverters which one of the cycloconverters had been as a series APF and the other one as a shunt APF to achieve a desired output signals with low voltage DG systems. High frequency transformer stepped up voltage of the primary side, reduces the converter volume and also provided an electrical isolation between input DG and main grid. State space equations for modes of the proposed converter were presented for dynamic analysis and provided proper control based on phase shift with nonlinear control. The nonlinear controller was based on Input-Output feedback Linearization for achieving some prescribed behavior of the proposed UPQC-DG in mitigation of power quality problems. The performance of the proposed system was analyzed via simulation with PSCAD/EMTDC analysis program software and validated the good performance of the proposed configuration in power quality problems compensation.

III. Problem Formulation Proposed Approach

Nowadays, PQ related issues are of most concerned because of their importance in power operating devices. Nonlinear loads such as adjustable speed drives (ASD), programmable logic controllers (PLC), energy-efficient lighting and rectifiers, led to PQ problems. Common PQ problems are voltage sag, voltage spike, voltage swell, harmonic distortion, voltage fluctuations, voltage unbalance and interruptions. If the system maintains the PQ, it will provide stable operation or else it provides unstable operation. So maintaining of PQ is an essential one in power operating device. From the related research works, it shows that intelligent techniques are adopted in various electrical and electronics applications. In the previous papers intelligent techniques are being used for improving the PQ problem compensating performance of UPQC.

This technique improves the performance of UPQC in PQ problem compensation by optimizing the output of the NN which provides the PQ disturbance in terms of voltage to the bias voltage generator. Bias voltage generator is the replacement for DC link capacitor which acts as a DC voltage source for two active power filters of UPQC. DC link capacitor has the disadvantage of long discharging time due to which full compensation of the voltage disturbances is not possible and getting delayed. To avoid these issues, bias voltage generator is used in the place of DC capacitor. Bias voltage generator regulates the DC link voltage fast and effectively for better compensation of PQ problem. Bias voltage generator has two inputs: reference voltage and

calculated voltage from NF controller. In this paper, ABC optimization algorithm based NF controller is proposed, which is an improvement over the existing NF controller and ANFIS controller for improving the compensating performance of the UPQC.

I. Need for Advancement in Proposed approach

As of now, various research works have been tried in the section of PQ maintenance and enhancement. Some devices such as DVR, UPS and many others are used for maintaining the quality power supply. But, these devices are capable of maintaining only the symmetrical or unsymmetrical power supplies, so the PQ is not maintained at all time. To avoid these problems, an enhanced NF controller [29] has been proposed. But, the system developed by [29] had drawbacks like they can only be applied to small networks.

Hence, to overcome the issue involved in previous methods, we have proposed an ABC optimization algorithm based NF controller. Output of the NN is given to ABC algorithm and then the output DC link voltage of the bias voltage generator is optimized so that compensation performance of the PQ problem is achieved effectively. ABC algorithm is an optimization algorithm inspired by intelligent food foraging behavior of honey bee swarm and is invented by Karaboga in 2005. It can be used in unconstrained or constrained optimization problem. It is effectively applied in NN training, cluster analysis, face pose estimation etc.

II. Proposed NF controller for UPQC based on ABC algorithm

UPQC is power electronics based power conditioning device, designed to compensate both source current and load voltage imperfections. The UPQC device combines a shunt active filter together with a series active filter in a back-to-back configuration by a DC link capacitor, to simultaneously compensate the supply voltage and load current. Series active filter is used for maintaining the problem related to voltage where as current related quality problems are handled by shunt active filter. Series active filter will compensate the source voltage waveform by injecting a voltage waveform opposite to the quality problem. To do this, DC link voltage of the series active filter should be constant which could be affected by delay discharging time of the DC link capacitor.

To regulate the DC link voltage, discharging time of the DC capacitor should be eliminated. Here, we replaced DC capacitor with bias voltage generator for eliminating the drawback of the DC capacitor. In this paper, Artificial Bee Colony (ABC) based NFC is proposed for regulating the DC link voltage and reducing the harmonics of the inverter. The NFC has combined neural network and fuzzy logic controller. Here, NFC is used to improve the voltage regulation and reduce the complexity. Then the error and change of error voltages are applied to the input of the neural network. The output of the neural network is regulated DC link voltage. The output performance of the neural network is optimized by using the ABC algorithm. Then the determined dc link voltage is applied to the regulation system of UPQC and the PQ problem is compensated.

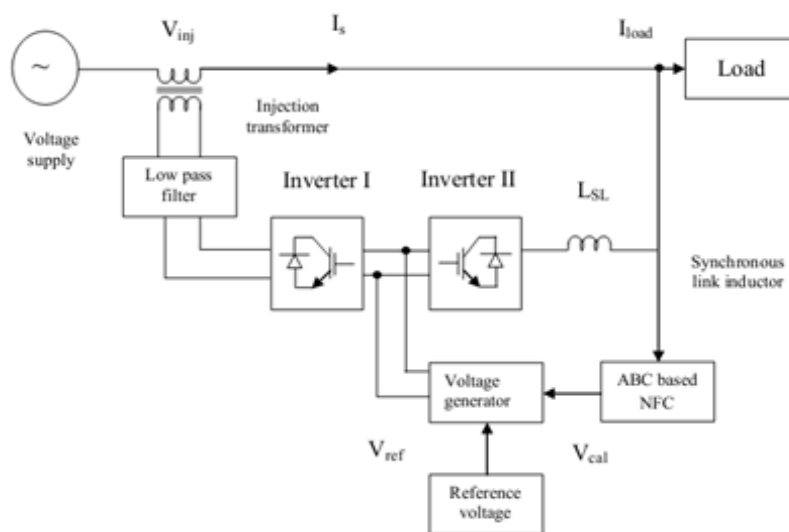

Figure 1: General structure of the proposed NFC based on ABC algorithm for UPQC

Enhanced NFC based UPQC controller for PQ maintenance in a single phase load connection is illustrated in Figure1. It consists of bias voltage generator which connects both Series Active Filter (SAF) and

Shunt Active Filter (SHAF). Here, the inputs to the bias voltage generator are Reference Voltage (V_{ref}) and calculated Voltage (V_{cal}) which is calculated from NF controller based on ABC algorithm. A Synchronous Link In (V_{ref}) inductor (L_{SL}) is connected in series with SHAF to generate a voltage with respect to the PQ disturbance and a low pass filter is connected in series with SAF to pass low frequency component and to reduce the high frequency component of specific voltage signal. Then, the output of low pass filter is applied to voltage injection transformer. Hence, the obtained output from injection transformer maintains PQ in the operating system. Injected voltage in phase by injection transformer is expressed as

$$V_{inj} = \sqrt[2]{V_{s1}^2 - V_{s2}^2} \tag{1}$$

$$V_{inj} = \frac{mV_{dc}}{2\sqrt{2}} \tag{2}$$

where, V_{inj} is the injected voltage in the phase, V_{s1} is the pre voltage variation, V_{s2} is the post voltage variation, m is the modulation index and V_{dc} is the normal rated DC voltage respectively.

The output voltage and current of single phase system can be expressed as follows,

$$V_{output} = A \cdot \sin(\omega t + \theta) \tag{3}$$

$$I_{output} = I_s \cdot \cos \omega t \cdot \cos \theta \tag{4}$$

Where, A is the amplitude of output voltage, ω is the angular frequency and θ is the phase angle of output voltage at $t=0$. Using Equation 3 and 4 the sinusoidal output voltage and current are calculated. The PQ of the supply is mainly depends on the output voltage of the system. Hence, in the paper the PQ of the system output voltage is maintained only during the time of system operation. Here, the voltage discharge capacitor of conventional UPQC is replaced by the bias voltage generator. As stated earlier, one of the inputs of the bias voltage generator V_{cal} is generated by NF controller based on ABC algorithm. The generation of V_{cal} is described as follows.

3.2.1 Bias voltage generator using proposed approach

The bias voltage generator is used for eliminating the effects of high discharging time of the DC link capacitor. ABC optimization algorithm optimizes the output of the calculated voltage from NN controller so that the output of NF controller is able to inject the compensating voltage in the single phase line. Inputs to the NF controller are error voltage and change in error voltage of the device and are determined shown below,

$$E(k) = V_{dc}(ref) - V_{dc} \tag{5}$$

$$\Delta E = E(k) - E(k-1) \tag{6}$$

Where, $E_{(k-1)}$ is the previous state error. The error voltage and change of error voltage are calculated by using the above formula and the values are applied to the inputs of NF controller. Output of NN is optimized with ABC algorithm so that the hybridized output of the NF controller improves the performance of UPQC. The function of NF controller and ABC algorithm are explained in the below section.

Stage I: Bias voltage generator using NN

NN is the artificial intelligence technique for estimating the output based on its training and doesn't need any mathematical model for its structure. It has played a major role in the maintenance of PQ in recent research works. Participation of NN in proposed method is explained below.

Proposed NN for providing calculated voltage for bias voltage generator is shown in Fig.3. It is a feed forward NN. It consists of three layers: input layer, hidden layer and output layer. It has two inputs E_k and ΔE_k , n nodes of hidden layer and one output V_{cal}^{NN} . The process of NN is performed in the hidden layer. Labeled with 'N' are nodes of the NN and labeled with 'w' are the weights of the NN. Back Propagation (BP) algorithm is used for NN training in this paper and it is briefed in the following steps,

Step 2: calculate the network output (V_{cal}^{NN}).

Step 3: Determine the BP error (BP_{error}) by subtracting the network output from target output.

Step 4: Adjust the weight ($W_{new} = W_{old} + \Delta E$) of each neuron in the network by determining Δw .

Step 5: Repeat the process until BP error gets minimized to a least value i.e., 10. $BP_{error} < 1$.

This is how; we train the NN by back propagation for providing V_{cal}^{NN} values for any error values. After training NN is capable providing V_{cal}^{NN} for different error values. For improving the performance of NN,

calculated voltage is optimized with ABC algorithm so that, effective compensation performance of the UPQC is achieved. Optimization of the V_{cal}^{NN} by ABC algorithm is explained in below.

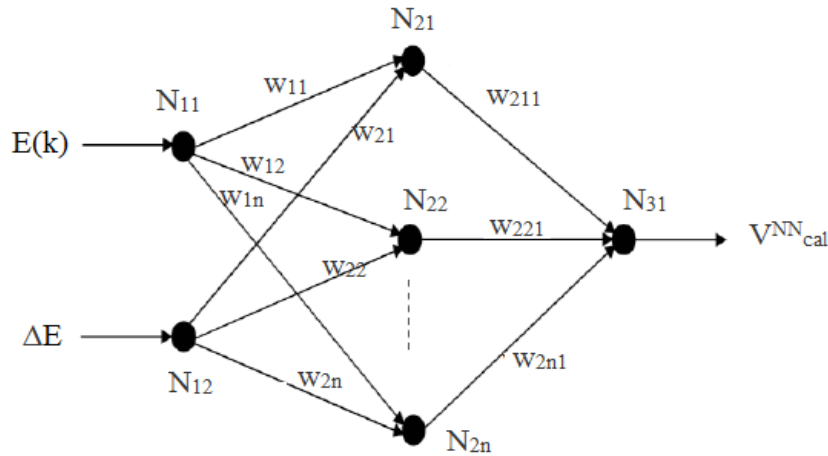

Figure 3: Proposed NN structure.

Step 1: initialize the inputs $E_{(k)}$ & $\Delta E_{(k)}$ and weights of the network.

3.3 Optimization of NN output using ABC optimization algorithm

In ABC algorithm, a colony of artificial forager bees (agents) search for rich artificial food sources (good solutions for a given problem). To apply ABC, the considered optimization problem is first converted to the problem of finding the best parameter vector which optimizes the objective function. Then, the artificial bees randomly discover a population of initial solution vectors and then iteratively improve them by employing the strategies: moving towards better solutions by means of a neighbor search mechanism while abandoning poor solutions. There are three control parameters in the algorithm, they are: population size, maximum cycle number and limit. These should be predetermined by the user.

Here, optimization problem is minimizing the error (e) between Reference Voltage (V_{ref}) of the bias voltage generator and calculated voltage V_{cal}^{NN} from NN. Minimization of error will result in the effective regulation of DC link voltage thus improves the compensation performance of UPQC. This is achieved by optimizing V_{cal}^{NN} with ABC algorithm. Input of the ABC is algorithm is the output of the NF controller i.e., V_{cal}^{NN} . General optimization problem is expressed as below.

$$\text{minimize}(e) = V_{ref} - V_{cal}^{NN} \tag{8}$$

ABC algorithm consists of five operation phases, they are: Initialization Phase, Employed Bees Phase, Onlooker Bees Phase, Scout Bees Phase, Termination Phase. To optimize the equation 8, ABC algorithm is executed as follows,

- 1) Initialization Phase
- 2) In this phase, initially population of food sources are randomly generated using equation (9).

$$x_{md} = l_d + \alpha \cdot (u_d - l_d) \tag{9}$$

Where, X_{md} is the m^{th} food source in the population of P size, 'd' is number of parameters which affect the optimization. Here, we have only one parameter V_{cal}^{NN} and its lower and upper bounds are l_d and u_d respectively. α is the random number between (0,1).

- 3) Employed Bees Phase
- 4) In employed bee phase, Employed bees are equal to the size of the population. They search for new food sources \tilde{V}_m having more nectar within the neighborhood of their memory using equation (10).

$$v_{md} = x_{md} + \beta \cdot (x_{md} - x_{kd}) \tag{10}$$

Where \tilde{x} is a randomly selected food source, d is a randomly chosen parameter index and β is a random number within the range [-a, a]. After producing the new food source \tilde{V}_m , its fitness is calculated and a greedy selection is applied between \tilde{x}_m and \tilde{V}_m . Finally, they return to the dancing area in the hive to share the fitness information with the Onlookers bees.

Onlooker Bees Phase

In this phase, an onlooker bee chooses a food source depending on the probability values calculated using the fitness values provided by employed bees. Choosing a food source by Onlooker is expressed in equation (11) is given as,

$$P_m = \frac{fit(\bar{x}_m)}{\sum_m^{SN} fit_m(\bar{x}_m)} \quad (11)$$

Here, the probability value P_m with which \bar{x}_m is chosen by an onlooker bee, $fit(\bar{x}_m)$ is the fitness value of \bar{x}_m . After a food source \bar{x}_m for an onlooker bee is probabilistically chosen, a neighborhood source \tilde{V}_m is determined by using equation (10), and its fitness value is computed. As in the employed bees phase, a greedy selection is applied between V_m and \bar{x}_m .

5) Scout Bees Phase

6) In this phase, those employed bees whose solution is not improved through a predetermined number of trials, specified by the user of the ABC algorithm and called “limit” or “abandonment criteria” herein, become scouts and their solutions are abandoned. Then, the converted scouts start to search for new solutions, randomly using equation (9) with different α value. Until now, best solution achieved so far is memorized, i.e., V_{cal}^{NN} optimized achieved so far is memorized.

Termination phase

From employed bee phase to scout bee phase is continuously repeated until the termination condition is satisfied. Generally, termination condition is Maximum Cycle Number (MCN) or Maximum CPU time. In the end, best food source with high fitness value in the whole swarm is presented as output. Here, best solution V_{cal}^f in the whole swarm is given as output. This is how, we optimize the output of NN using ABC algorithm. After optimizing the calculated voltage from NN, calculated voltage through FLC is computed. Then the hybridized output of both techniques is given to bias voltage generator. Calculated voltage using FLC is clearly explained in stage II section.

Stage II: Bias Voltage Generator Using FLC

FLC is a rule based controller based on fuzzy logic for giving the output without vagueness. It has major significance in the research of PQ enhancement. Mainly, it consists of three parts they are: Fuzzification, fuzzy rules and defuzzification. Fuzzification means changing the input and output crisp sets into fuzzy sets. Fuzzy sets are the membership function of the crisp set and range from 0 to 1. Most used membership function are trapezoids and triangular. This is the first stage of the FLC. In this paper, inputs are error and change in error voltage of the device, output is calculated voltage (V_{cal}^f) and membership functions are triangular fuzzy sets.

After Fuzzification of input and output crisp sets, fuzzy rules are created based on the fuzzy sets of inputs and outputs by using knowledge of experts and a decision will be taken. This is the middle stage of the FLC and called as fuzzy inference system (FIS). Using the fuzzy rules, the input of bias voltage generator is selected from fuzzy inference system. After a decision made, output which is in fuzzy set form is converted back to crisp set by defuzzification. Most used defuzzification method is centroid or min-max method. This is the last stage of the FLC.

Here, by using centroid defuzzification method, output of the FLC i.e., calculated voltage (V_{cal}^f) which is the input to bias voltage generator is determined. The structure of designed FLC is illustrated in Figure 2. Proposed FLC is shown in Figure.2, the inputs of FLC are error ‘ $E_{(k)}$ ’, change of error voltage ‘ ΔE ’ and the output is calculated voltage ‘ V_{cal}^f ’. The linguistic variables of inputs and output are Negative Big, Negative Medium, Negative Small, Zero, Positive Small, Positive Medium, Positive Big and it is referred as NB, NM, NS, ZE, PS, PM, PB in the rules base. The developed fuzzy rules are tabulated in TABLE I. Using optimal fuzzy rules, V_{cal}^f is determined.

The DC link voltage of the UPQC is varied according to the variation of load voltage. By using the output of ABC algorithm based NF controller, DC voltage regulation is achieved via bias voltage generator. Inputs of the bias voltage generator are taken as V_{ref} and the calculated voltage V_{cal}^f , which is obtained NF controller based on ABC algorithm. Bias voltage generator is used to quickly discharge the inverter diodes. The harmonics of inverter output voltage is eliminated by the low pass filter, and then the low pass filter output is applied to injection transformer. The output of injection transformer is the delivered the enhanced voltage of the system. Then the Root Mean Square (RMS) voltage (V_{rms}^f) of enhanced voltage is calculated as follow.

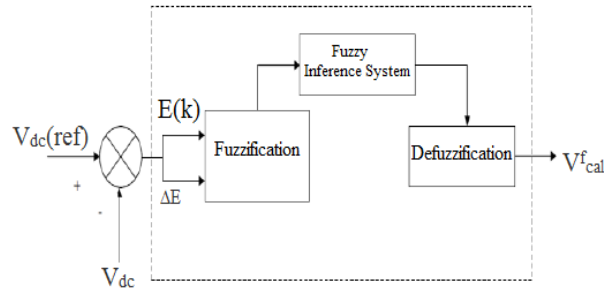

Figure 2: proposed FLC for calculating voltage V_{cal}^f .

Table I: Fuzzy rules for determining V_{cal}^f

ΔE E(k)	NB	NM	NS	ZE	PS	PM	PB
NB	NB	NB	NB	NB	NM	NS	ZE
NM	NB	NB	NB	NM	NS	ZE	PS
NS	NB	NB	NM	NS	ZE	PS	PM
ZE	NB	NM	NS	ZE	PS	PM	PB
PS	NM	NS	ZE	PS	PM	PB	PB
PM	NS	ZE	PS	PM	PB	PB	PB
PB	ZE	PS	PM	PB	PB	PB	PB

$$V_{rms} = \frac{v_p}{\sqrt{2}} \tag{13}$$

Where, V_p is the peak value of voltage. The RMS voltage value is used to estimate the PQ enhancement of the operating system.

IV. RESULTS AND DISCUSSION

The proposed method is used to compensate the power quality problems by means of improving the performance of UPQC. The proposed (ABC-NFC) method is implemented in MATLAB platform. The performance of the proposed controller is analyzed. In this section, the implementation parameters are specified. The DC voltage (V_{DC}) and the reference voltage value is taken as ± 230 . Then the error voltage $e(n)$ and the change of error voltage Δe value is specified the range from -230 to +230. The line voltages are represented as the various time instants. The reference voltage is affected from the PQ disturbance signal. Also, the PQ disturbance voltage signal is represented as the various time instant. Then the performances of the proposed method are compared to the existing methods.

IV.1 Performance Analysis

In this section, the reference voltage and line voltage with PQ problem are determined with the various instant of time. By using the proposed controller, the PQ affected line voltage has been enhanced. Also, the enhancements of existing techniques are ANFIS, ANN, FLC and NFC, which techniques are compared with the proposed method. The reference voltage, line voltage with PQ problem and the line voltage with enhanced PQ are defined with the various time instants ($T=0.01, 0.064, 0.105, 0.106, 0.1404$ sec) are illustrated in Figure 4, 5, 6, 7, 8 and 9. Here, the PQ problems are occurring in ANFIS, ANN, FLC and NFC at 0.01 seconds then clearing at 0.025, 0.028, 0.024 and 0.03 seconds respectively. In the proposed controller, the PQ problems are occurring at 0.01 seconds and clearing at 0.02 seconds. So, the total PQ problem duration is 0.01 seconds. In the time instant ($T=0.064$), the PQ problems are occurring in ANFIS, ANN, FLC and NFC are specified. Then the PQ problems are clearing at 0.07, 0.081, 0.082 and 0.083 seconds respectively. In the proposed controller, the PQ problems are occurring at 0.064 seconds and clearing at 0.065 seconds. So, the total PQ problem duration is 0.01 seconds. Similarly, the enhanced PQ problem waveforms with the existing methods are evaluated with the various time instants ($T=0.064, 0.105, 0.106$ and 0.1404 sec).

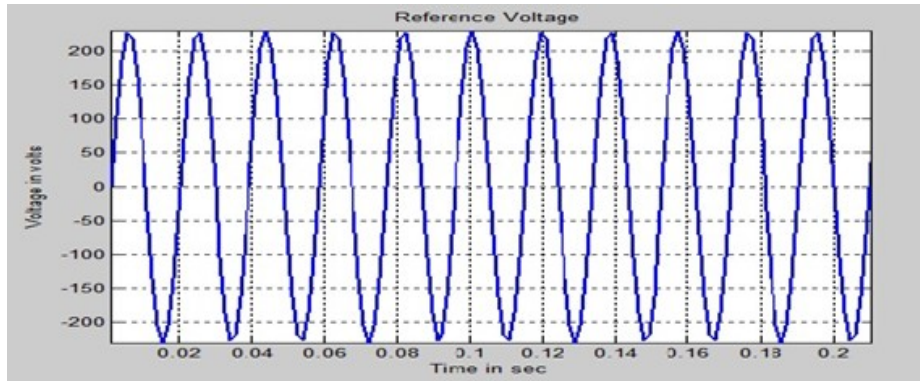

Figure 4: Reference voltage

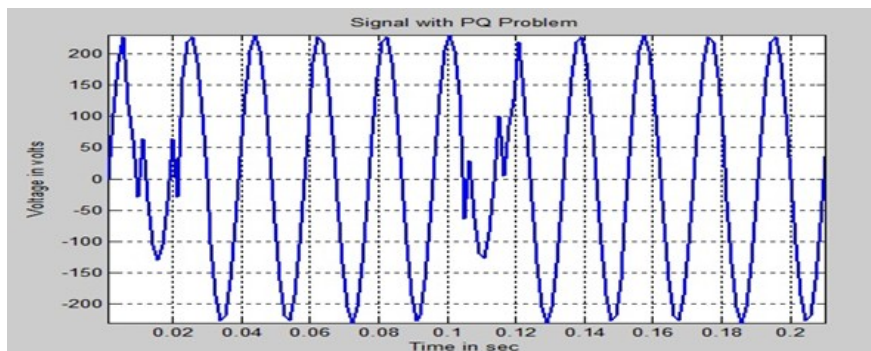

Figure 5: Line voltage with PQ problem at T=0.01sec

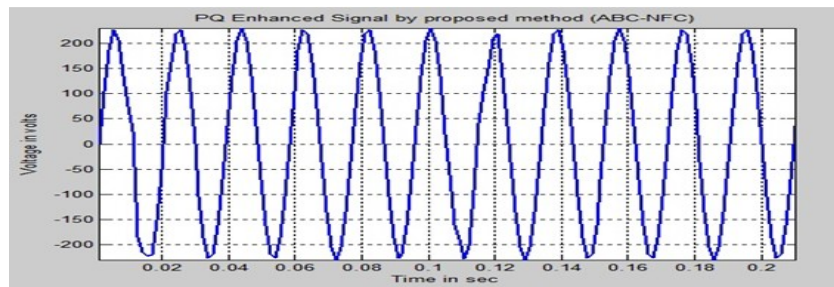

Figure 5(a): Line voltage with PQ problem at T=0.01sec

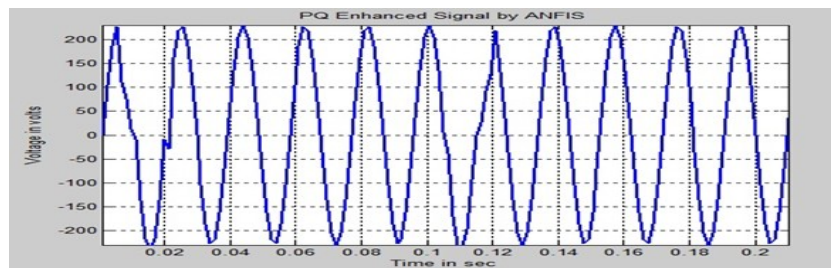

Figure 5(b): Line voltage with PQ problem at T=0.01sec

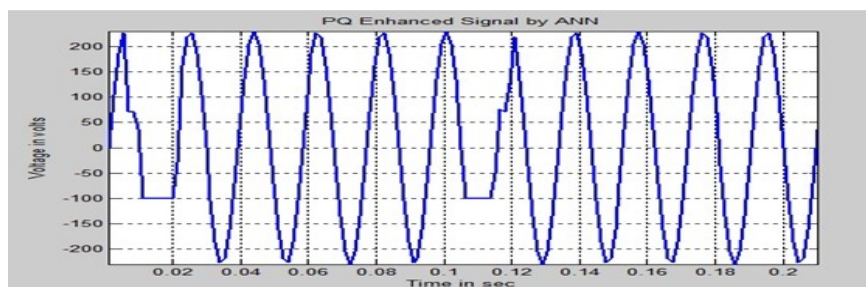

Figure 5(c): Line voltage with PQ problem at T=0.01sec

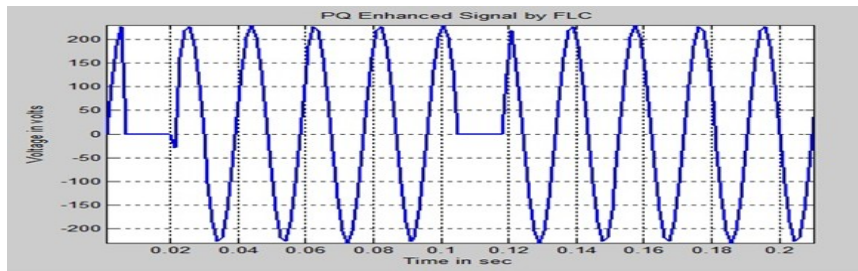

Figure 5(d): Line voltage with PQ problem at T=0.01sec

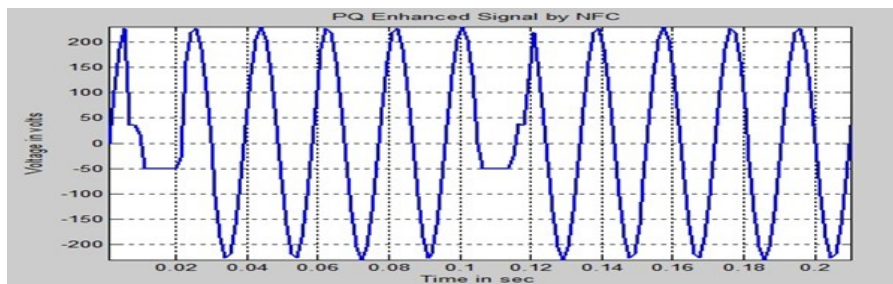

Figure 5(e): Line voltage with PQ problem at T=0.01sec

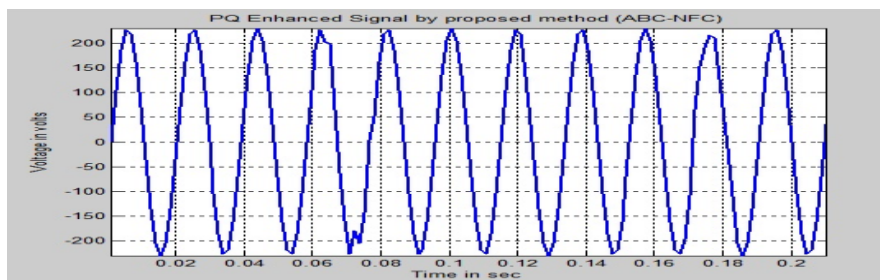

Figure 6: Line voltage with PQ problem at T=0.064sec

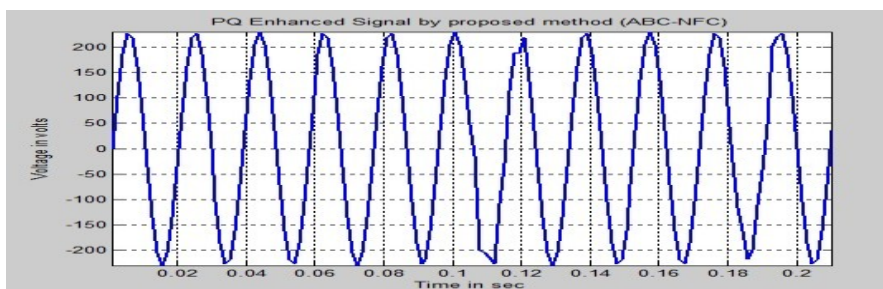

Figure 7: Line voltage with PQ problem at T=0.105sec

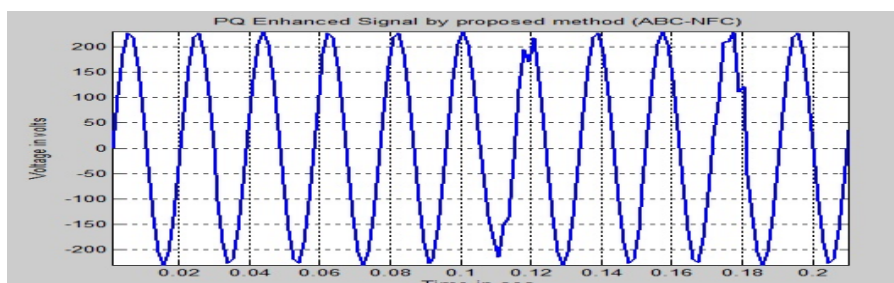

Figure 8: Line voltage with PQ problem at T=0.106sec

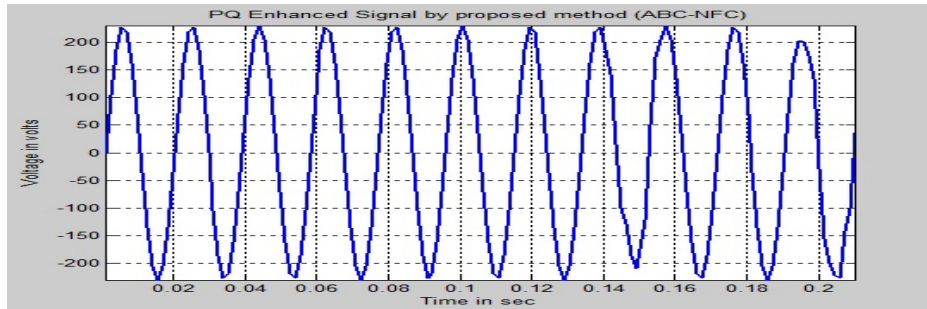

Figure 9: Line voltage with PQ problem at T=0.1404sec

Here, the existing techniques are taken more time to solve the PQ problem when compared to the proposed method. From the above performance illustrations, the proposed and existing technique processes are noted. Then, the ABC-NFC controller is used for solving the PQ problems in an efficient time manner. From the above illustrations, the RMS voltage of the proposed and existing method is calculated. The RMS voltages of the proposed and existing method are evaluated. The table II shows that, the RMS voltage of the proposed and ANFIS, NFC, FLC and ANN controller. Moreover, the RMS voltage of the existing methods gets decreased compared to the proposed method, when the PQ problem is occurred.

Table II: RMS voltages of ABC-NFC, ANFIS, ANN, FLC and NFC

Time instant in sec at which the PQ error occurs	RMS Voltage (in Volts) when PQ issue occurs	RMS Voltage (in Volts) after PQ enhancement				
		ABC-NFC	ANFIS	ANN	FLC	NFC
0.01	70.72136	127.29844	77.79349	53.04102	60.11315	28.28854
0.064	84.86563	141.44272	84.86563	49.50495	24.75248	31.82461
0.105	70.72136	134.37058	35.36068	56.57709	31.82461	31.82461
0.106	120.22631	134.37058	113.15417	109.61810	113.15417	109.61810
0.1404	113.15417	141.44272	113.15417	113.15417	109.61810	109.61810

4.2 Evaluation of Performance Metrics

In the proposed technique is analyzed with the performance deviation of ANFIS, NFC, FLC and ANN controller. The performance deviation between the ABC-NFC and ANFIS controller can be calculated with the following formula,

$$Deviation (\%) = \frac{V_{rms}^{ABC-NFC} - V_{rms}^{ANFIS}}{V_{rms}^{ABC-NFC}} * 100$$

Similarly, the performance deviation can also be calculated between ABC-NFC and FLC, NFC and ANN for different instances of occurrence of PQ issues and that are chosen for implementing the proposed controller are tabulated in TABLE III.

Table III: Performance deviation of ABC-NFC with ANFIS, ANN, FLC and NFC

Time (in sec)	Performance Deviation of ABC-NFC			
	ANFIS	ANN	FLC	NFC
0.01	38.88889	58.33333	52.77778	77.77778
0.064	40	65	82.5	77.5
0.105	73.68421	57.89473	76.31579	76.31579
0.106	15.78948	18.42106	15.78948	18.42106
0.1404	20	20	22.50001	22.50001

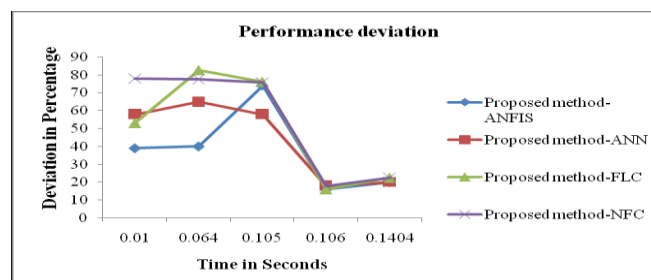

Figure 10: Performance deviation of proposed method with ANFIS, ANN, FLC and NFC

In the proposed controller, the performance deviation are calculated and represented in fig 10. It can be deviates positively at a rate of 77.78% rather than NFC, 52.78% rather than FLC, 38.89% rather than ANFIS and 58.33% rather than ANN-based controller at T=0.01sec. Then, the time instant (T=0.064 sec), the proposed controller deviates at a rate of 77.5% rather than NFC, 52.78% rather than FLC and 38.89% rather than ANFIS, 58.33% rather than ANN. Similarly, the performance deviation of the proposed technique achieves a positive rate in solving the defined time (T=0.105, 0.106, 0.1404 sec) instants. It can be shown that, the proposed (ABC-NFC) controller can achieve a better performance of PQ issues compared with the ANFIS, FLC, NFC and ANN.

V. CONCLUSION

In this paper, PQ problem was compensated by the proposed (ABC-NFC) technique. The voltage sag PQ problems were considered for analyzing the performance of the proposed controller. Then, the proposed and existing technique results were evaluated and compared. The line voltage with the PQ problems was occurred in the various time instants. The proposed controller was compensated the PQ problem in less time, when compared to the existing methods. Also, the PQ problem occurrences are defined with the different time instants (T=0.01, 0.064, 0.105, 0.106, 0.1404 sec) the performance deviations were evaluated in the proposed controller with the ANFIS, NFC, ANN and FLC techniques. The proposed technique achieves a positive rate in solving all the defined instants of occurrences of PQ issues. The comparative results showed that the proposed controller can achieve a better performance of PQ issues compared with the ANFIS, FLC, NFC and ANN based controllers.

REFERENCES

- [1] B Jyothi, B Jyothsna Rani and M Venu Gopal Rao, "Analysis Of Unified Power Quality Conditioner During Voltage Sag And Swell Conditions", International Journal Of Engineering Science & Advanced Technology, Vol.2, No.1, pp.85-91, 2012.
- [2] B Kumara Swamy, P Pavan Kumar and Ch V K R M V Prasad, "A MATLAB Based Power Quality Analyzer (PQA) For Enhancing Power Quality In The System", International Journal Of Electrical And Electronics Engineering Research, Vol.3, No.1, pp.73-86, 2013.
- [3] T Devaraju, V C Veera Reddy and M Vijaya Kumar, "Role of custom power devices in Power Quality Enhancement: A Review", International Journal of Engineering Science and Technology, Vol.2, No.8, pp.3628-3634, 2010.
- [4] S Khalid and Bharti Dwivedi, "Power Quality: An Important Aspect", International Journal of Engineering Science and Technology, Vol.2, No.11, pp.6485-6490, 2010.
- [5] C Nalini Kiran, "Power Quality Improvement Using Active and Passive Power Filters", International Journal of Modern Engineering Research, Vol.2, No.1, pp.76-79, 2012.
- [6] S H Laskar and Mohibullah, "Power Quality Issues and Need of Intelligent PQ Monitoring in the Smart Grid Environment", International Journal of Emerging Technology and Advanced Engineering, Vol.2, No.9, pp.63-69, 2012.
- [7] Nagendrababu Vasa, Sreekanth G, Narender Reddy Narra and Srujana A, "Series Compensation Technique for Voltage Sag Mitigation", International organization of Scientific Research Journal of Engineering, Vol.2, No.8, pp.14-24, 2012.
- [8] Mahesh A Patel, Ankii R Patel, Dhaval R Vyas and Ketul M Patel, "Use of PWM Techniques for Power Quality Improvement", International Journal of Recent Trends in Engineering, Vol.1, No.4, pp.99-102, 2009.
- [9] Paduchuri Chandra Babu and Subhransu Sekhar Dash, "Design of Unified Power Quality Conditioner (UPQC) Connected To Three Phase Four Wire System", International Journal of Computer and Electrical Engineering, Vol.4, No.1, pp.60-64, 2012.
- [10] Saleha Tabassum and B Mouli Chandra, "Power Quality Improvement By UPQC Using ANN Controller", International Journal of Engineering Research and Applications, Vol.2, No.4, pp.2019-2024, 2012.
- [11] Laxman Rao and Hari Krishna, "Enhancement of Power Quality by UPQC Device in SCIG Wind Farm to Weak Grid Connection", International Journal of Modern Engineering Research, Vol.2, No.5, pp.4030-4033, 2012.
- [12] Yash Pal, A Swarup and Bhim Singh, "3P-3W UPQC with zig-zag transformer for 3P-4W Distribution System", International Journal on Electrical Engineering and Informatics, Vol.4, No.2, pp.231-244, 2012.
- [13] G Sridhar Reddy, "Feasibility Analysis of DGSC-UPQC", International Journal of Research and Reviews in Applied Sciences, Vol.4, No.1, pp.32-47, 2010.
- [14] Seema P Diwan, H P Inamdar and A P Vaidya, "Simulation Studies of Shunt Passive Harmonic Filters: Six Pulse Rectifier Load-Power Factor Improvement and Harmonic Control", International Journal on Electrical and Power Engineering, Vol.2, No.1, pp.1-6, 2011.
- [15] Yash Pal, A Swarup and B Singh, "A New Topology of Three-Phase Four-Wire UPQC with a Simplified Control Algorithm", Majlesi Journal of Electrical Engineering, Vol. 6, No. 1, pp.24-30, 2012.
- [16] G Laxminarayana and G Umesh Kumar, "Power Quality Improvement Using UPQC for Wind Farm Generation System", International Journal of Advanced Research in Electrical, Electronics and Instrumentation Engineering, Vol.1, No.6, pp.523-530, 2012.
- [17] Yash Pal, A.Swarup and Bhim Singh, "Star-Hexagon Transformer Supported UPQC", International Journal of Electrical and Electronics Engineering, Vol.5, No.1, pp.63-68, 2011.
- [18] K Sandhya, A Jayalaxmi and M P Soni, "Design of Unified Power Quality Conditioner (UPQC) for Power Quality Improvement in Distribution System", International organization of Scientific Research Journal of Electrical and Electronics Engineering, Vol.4, No.2, pp.52-57, 2013.
- [19] Nadezda Stanarevic, "Hybridizing artificial bee colony (ABC) algorithm with differential evolution for large scale optimization problems", International Journal of Mathematics And Computers in Simulation, Vol.6, No.1, pp.194-202, 2012.
- [20] Milan Tuba, Nebojsa Bacanin and Nadezda Stanarevic, "Adjusted artificial bee colony (ABC) algorithm for engineering problems", WSEAS Transactions on Computers, Vol.11, No.4, pp.111-120, 2012.
- [21] Sobha Rani Injeti and K Ratna Raju, "Power Quality Improvement by UPQC device in Doubly Fed Induction Generator Wind Farm to Weak-Grid Connection", International Journal of Scientific and Engineering Research, Vol.2, No.12, pp.1-7, 2011.

- [22] Yash Pal, A Swarup and Bhim Singh, "A control strategy based on UTT and I Cos Φ theory of three-phase, fourwire UPQC for power quality improvement", International Journal of Engineering, Science and Technology, Vol.3, No.1, pp.30-40, 2011.
- [23] M Siahi, M Najafi, M Hoseynpoor and R Ebrahimi, "Design and Simulation of UPQC to Improve Power Quality and Transfer Power of photovoltaic array to grid", Australian Journal of Basic and Applied Sciences, Vol.5, No.3, pp.662-673, 2011.
- [24] K S Ravi Kumar and S V A R Sastry, "Application of PI, Fuzzy Logic and ANN in Improvement of Power Quality using UPQC", International Conference on Sustainable Energy and Intelligent Systems, pp.316-319, 2011.
- [25] G Siva Kumar, B Kalyan Kumar and Mahesh K Mishra, "Mitigation of Voltage Sags With Phase Jumps by UPQC with PSO-Based ANFIS", IEEE Transactions on Power Delivery, Vol.26, No.4, pp.2761-2773, 2011.
- [26] K. Manimala, K. Selvi and R. Ahila, "Optimization techniques for improving power quality data mining using wavelet packet based support vector machine", International Journal of Neuro computing, Vol.77, No.1, pp.36-47, 2012.
- [27] Yuksel Oguz, Seydi Vakkas Ustun, Ismail Yabanova, Mehmet Yumurtaci and Irfan Guney, "Adaptive neuro-fuzzy inference system to improve the power quality of a split shaft microturbine power generation system", International Journal of Power Source, Vol.197, pp.196-209, 2012.
- [28] A Mokhtarpour, M Bathae and H A Shayanfar, "Power Quality Compensation in Smart Grids with a Single Phase UPQC-DG", 2nd Iranian Conference on Smart Grids, pp.1-5, 2012.
- [29] S Deepa and S Rajapandian, "Voltage Sag Mitigation Using Dynamic Voltage Restorer System", International Journal of Computer and Electrical Engineering, Vol.2, No.5, pp.821-825, October 2010.



M. Vishnu vardhan obtained his B Tech degree in Electrical and electronics engineering from JNT University, Hyderabad. Then he obtained his M Tech degree in Power systems and Industrial drives from JNT University, Anantapur. Currently, he is pursuing PhD in the subject of power systems operation and control, topic area is Power quality and control, in EEE Department, in S.V. University, tirupati



Dr. P. Sangameswararaju received Ph.D from S.V. University, Tirupathi, Andhra Pradesh. Presently he is working as Professor in the Department of Electrical and Electronics Engineering, S.V. University, Tirupathi, Andhra Pradesh. He has about 50 publications in National and International Journals and Conferences to his credit. His areas of interest are in power system Operation & control and Stability