

Design, Modelling & Simulation of Double Sided Linear Segmented Switched Reluctance Motor

Dr. K. Ravi Chandrudu¹, T. Naga Jyothi², P. Yohan Babu³,
G. V. P Anjaneyulu⁴

^{1,2,3}EEE Department, KECW, Narasaraopeta, A.P. India

⁴ Research Scholar, S V University College of Engg, S V UNIVERSITY, A.P. India

Abstract: This paper presents the modelling, simulation, and speed control aspects of a 3-phase 6/4 linear switched reluctance motor (LSRM) drives. The Linear switched reluctance motor (LSRM) has never been a popular choice for direct-drive linear motion control system; because it is difficult to control and its output has high torque ripples. It is also due to the fact that the actuator's characteristic is highly dependent on its complex magnetic circuit, which is difficult to model, simulate, and control. Fourier series expression of phase self-inductance under the assumption of negligible mutual effect and various losses is introduced to describe the nonlinear dynamic model of SRM. Simulation results have shown the rationality of model and validity of control strategy. By virtue of MATLAB/SIMULINK, the models of various subsystems are achieved and the modelling procedure is described in detail. Linear segmented switched reluctance motor (LSSRM) using full pitched winding can give 40 - 80% higher torque than conventional SRM for the same frame size. This increase in torque is due to the increase in aligned inductance. However, full pitch winding results in high copper loss, and high active weight. Hence, in this paper, single tooth or concentric winding to replace the full pitch winding of LSSRM is proposed. In order to obtain the same flux paths as with full pitch winding, all the three phases must be excited simultaneously. The torque is produced due to changes in mutual inductance. This method of winding results in reduction of copper, and therefore, weight. With such an arrangement, one phase only requires DC supply.

Keywords: Linear Motion, Linear Switched Reluctance Motor, Stator, Rotor, chopping control.

I. Introduction

The use of switched reluctance machines (SRM) in variable speed applications is increasing because of the rugged construction and simple converter power circuit configuration. However, this machine has limitations such as low torque to weight ratio, acoustic noise, vibration and torque ripple. Some of these limitations namely low power density, acoustic noise are mitigated in segmented switched reluctance machine (SSRM) which has full pitched winding. It is shown there that SSRM can give 40 – 80 % higher torque than SRM for the same frame size. This increase in torque is because of the increase in aligned flux, while the torque of SSRM increases with the use of full pitch winding, the end winding volume of the motor also increases by a factor which depends on the ratio of motor air gap diameter (D) to stack length (L). For higher values of D/L ratio, as required in in-wheel electric vehicle (EV) or in fans, the copper loss and end winding volume become significantly higher than those corresponding to concentric winding. This arrangement is particularly more effective for machines with D/L ratio equal to and greater than 2.[4] LSSRM with concentric winding arrangement is henceforth referred to as SSRM. The difference is that the windings, instead of being full pitched, are concentric. Three concentric windings when excited together have the same effect as one full pitch winding.

II. Design Of Srm, SsrM, LsrM

In order to compare CSSSRM with SSRM, a 6kW, 2000 rpm machine as in [3] is designed and the machine dimensions are given in Table I. A 6/4 rotary SRM (SSRM) is designed for a power capacity identical to that of the LSSRM. The material used for the laminations is M19 steel, which is made of non oriented silicon steel. The rotary SRM has a stator pole angle and a rotor pole angle. The speed of the rotary SSRM N in rpm. D is the bore diameter of the rotary SSRM. The power output equation of a rotary SSRM is

$$P = k_e k_d k_1 k_2 B A_s D^2 L N_r \quad (1)$$

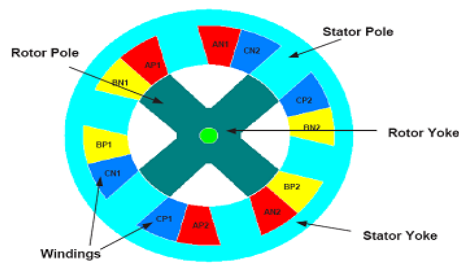

Fig.1: VSRM

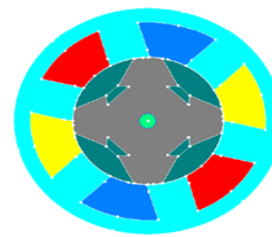

Fig.2: SSRM

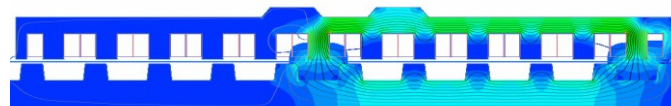

Fig.3: LSSRM

Where P is the power output, η is the efficiency, k_d is the duty cycle determined by the current conduction angle for each rising inductance profile, $k_1 = \frac{\alpha}{120}$, k_2 is a variable dependent on the operating point and is determined by using aligned saturated inductance and unaligned inductance, B is the stator pole flux density at the aligned position, A_s is the specific electric loading which is defined as ampere conductor per meter of stator inner periphery, L is the stack length of the magnetic core.

The bore diameter is obtained from the power output equation as

$$D = \sqrt{\frac{P \pi}{60 \cdot \eta \cdot k_e k_d k_1 k_2 k_B A_s v_m}} \quad (2)$$

For a power rating of 6kw, 2000rpm

Stack length = 114mm

Din = 80.648mm

From the above data we can calculate

Do/Din = 2

Do = 199.98mm

Normal SRM

1. Stator side design

Stator Pole Arc $\beta_s = \frac{2\pi}{p_s \times p_r / 2} \quad (3)$

Stator Pole Width $S_{pw} = \frac{D_m}{2} \beta_s \times \frac{\pi}{180} \quad (4)$

Stator Yoke Width $S_{yw} = \frac{A_{sy}}{L} \quad (5)$

Stator Pole Height $h_s = \frac{D_o}{2} - \frac{D_m}{2} - S_{yw} \quad (6)$

+2. Rotor Side Design

$$\text{Rotor Pole Arc } \beta_r > \beta_s \quad (7)$$

$$\text{Rotor Pole Width } R_{pv} = \left(\frac{D_m}{2} - g\right) \beta_r \times \frac{\pi}{180} \quad (8)$$

$$\text{Rotor yoke width } R_{yw} = \frac{A_{ry}}{L} \quad (9)$$

$$\text{Rotor Pole Height } h_r = \frac{D_m}{2} - g - \frac{D_{sh}}{2} - R_{yw} \quad (10)$$

From the Magnetic Circuit of Normal SRM

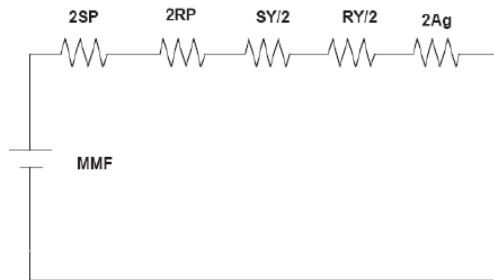

Fig. 4: Magnetic circuit for SRM

$$\text{Total reluctance} = 2RP + 2SP + 2Ag + \frac{RY}{2} + \frac{SY}{2} \quad (11)$$

Segmented SRM (SSRM)

1. Stator side design

$$\text{Stator Pole Arc } \beta_s = \frac{2\pi}{p_s \times p_r / 2} \quad (12)$$

$$\text{Stator Pole Width } S_{pv} = \frac{D_m}{2} \beta_{sactual} \times \frac{\pi}{180} \quad (13)$$

$$\text{Stator Yoke Width } S_{yw} = \frac{A_{sy}}{L} \quad (14)$$

$$\text{Stator Pole Height } h_s = \frac{D_o}{2} - \frac{D_m}{2} - S_{yw} - \text{poleshoe height} \quad (15)$$

2. Rotor side design

$$\text{Rotor Pole Arc } \beta_{ractual} = 2 \times \beta_{sactual} \quad (16)$$

$$\text{Rotor Pole Width } R_{pv} = \left(\frac{D_m}{2} - g\right) \beta_r \times \frac{\pi}{180} \quad (17)$$

$$\text{Rotor Pole Height } h_r = \frac{D_m}{2} - g - \frac{D_{sh}}{2} - R_{yw} \quad (18)$$

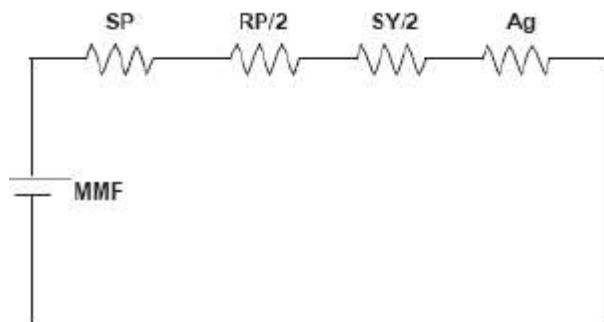

Fig. 5: Magnetic circuit for SSRM

$$\text{Total Reluctance} = A_g + SP + \frac{RP}{2} + \frac{SY}{2} \quad (19)$$

$$\text{Electrical Load} = \frac{2 \times T_{ph} \times I}{\pi \times D_m \times 10^{-3}} \quad (20)$$

$$\text{Size of the Conductor } J = \frac{I_p}{\sqrt{4a}} \quad (21)$$

Table 1: Design Data Of Vsrsm, Ssrsm

	VSRM	SSRM
OUTER DIAMETER	80.648mm	80.648mm
INNER DIAMETER	161.296mm	161.296mm
STACK LENGTH	114mm	114mm
STATOR POLE ARC	30	40
STATOR POLE WIDTH	28.150mm	28.150mm
STATOR YOKE WIDTH	21.1096mm	28.150mm
STATOR POLE HEIGHT	29.769mm	7.173mm
ROTOR POLE ARC	32	80
ROTOR POLE WIDTH	20.95mm	55.88mm
ROTOR YOKE WIDTH	6.59mm	-----
ROTOR POLE HEIGHT	19.4273mm	19.4273mm
RELUCTANCE	241606.76	82495.72
SHAFT DIAMETER	28mm	28mm
RATED CURRENT	15A	15A

III. Main Simulink Model

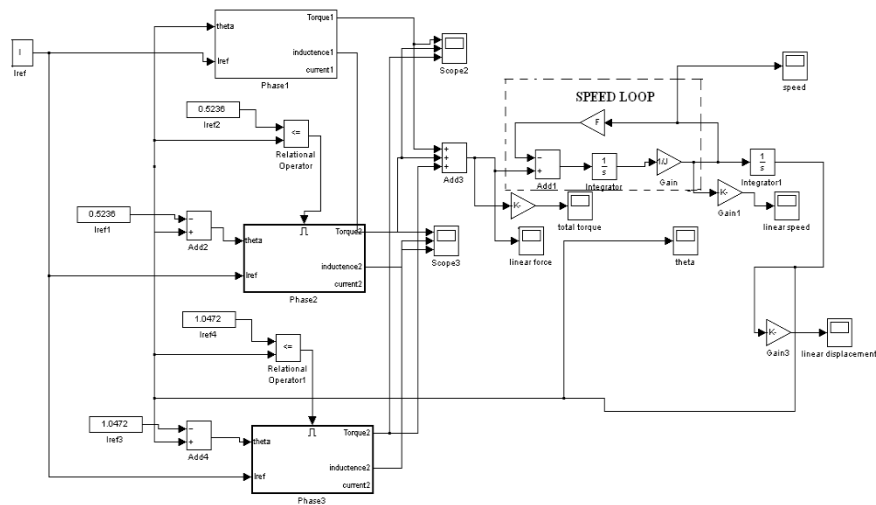

Fig. 6. Simulink Model for 6/4 LSSRM

IV. SIMULATION RESULTS

The Simulation results for current per phase, Inductance characteristics, Torque characteristics, linear speed of LSRM, Speed of LSSRM, are shown in Fig 7, Fig 8, Fig 9, Fig10, Fig11 as follows.

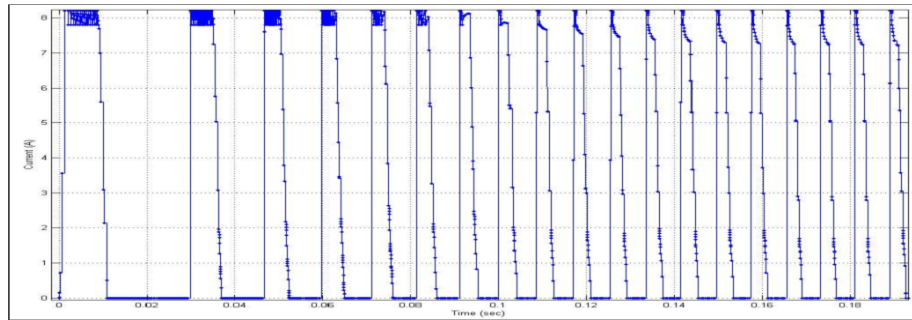

Fig. 7: Current per phase

The below figure shows the Inductance waveforms in three phases a, b, c respectively

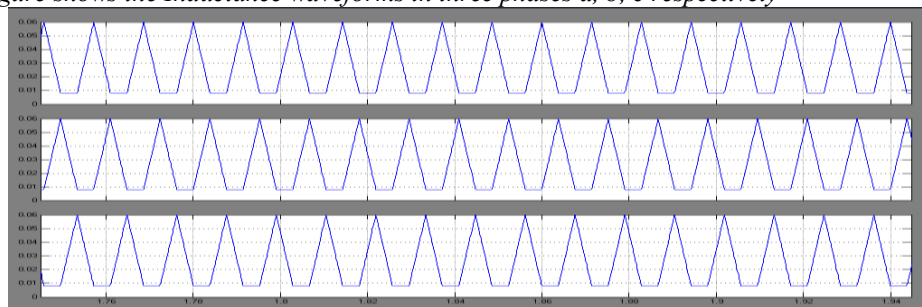

Fig. 8: Inductance characteristics

The below figure shows the Torque waveforms in three phases a, b, c respectively.

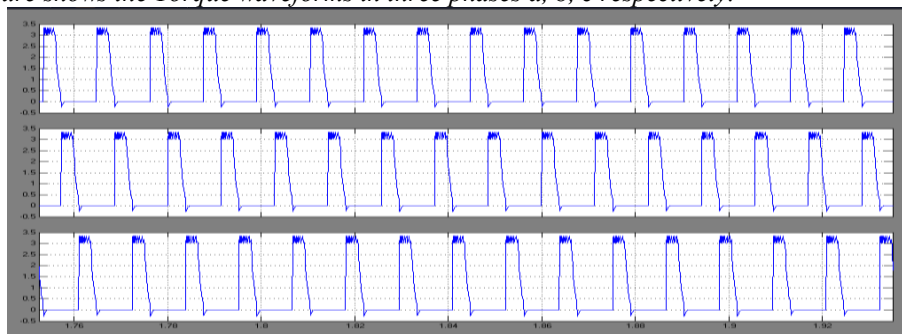

Fig. 9: Torque characteristics

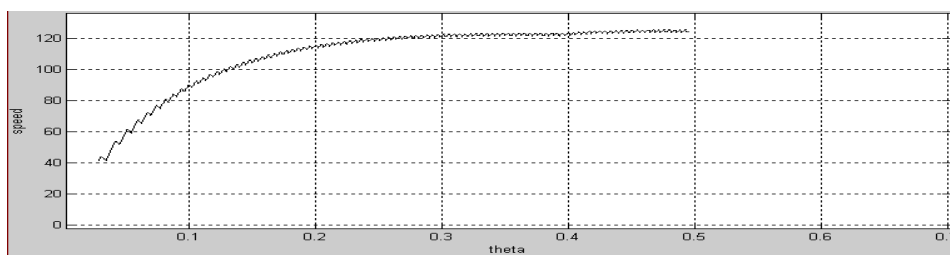

Fig. 10. Linear Speed of LSRM

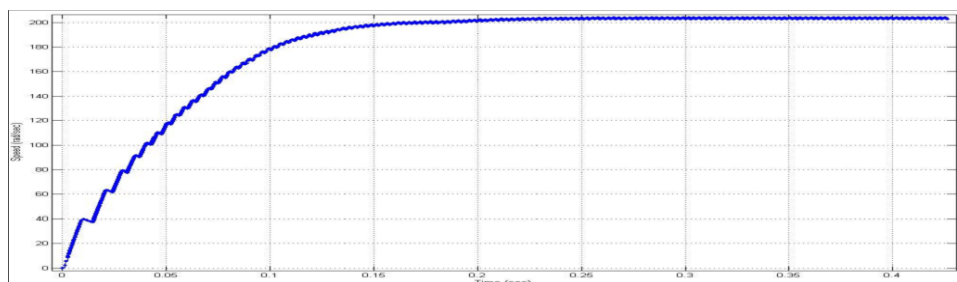

Fig. 11: Speed of LSSRM

V. Conclusion

A high torque and low weight Linear segmented switched reluctance (LSSRM) machine is proposed. Design for normal SRM, Segmented SRM, Linear SSRM and comparing the results. Non-linear dynamic model for simulating adjustable speed performance of a LSSRM drive has been described in detail. The model is a general one with simple representation in MATLAB functions. Good results can be achieved if the current shape, amplitude, advance angle and the pulse duration are controlled; the cost of manufacturing is less, as concentric coils are easier to wind than full pitched coils. The structure is mechanically robust as rotor segments are embedded in aluminium core. Factors affecting the average torque are identified.

References

- [1]. T. J. E Miller: "Switched reluctance motors and their control", Magna Physics Publications/Oxford university press (1993).
- [2]. R. Krishnan, "Switched Reluctance Motor Drives", Industrial Electronics Series, CRC Press (2001).
- [3]. J. Oyama, T. Higuchi, T. Abe and N. Kifuji, "Novel Switched reluctance motor with segmented core embedded in Aluminium rotor block," Papers of technical meeting on rotating machinery, IEEJ Trans, Vol.126, No.4, 2006.
- [4]. Mr. Myo Min, 'Design and Calculation of 75W Three-phase Linear Switched Reluctance Motor', The Department of Electrical Power Engineering, Mandalay Technological University, Myanmar
- [5]. Naresh Vattikuti, Vandana R and B. G. Fernandes "A high power density Outer rotor segmented switched reluctance motor" Indian Patent Application No 197/MUM/2009.
- [6]. Naresh Vattikuti, Vandana Rallabandi and B. G. Fernandes, "A Novel High Torque, Low Weight Segmented Switched Reluctance Motor", IEEE Power Electronics Specialist conference Issue 15-19, Pag. 1223-1228, Jun.82008, Rhodes, Greece.